



Since 1977

PIMTAS®

PLASTİK İNŞ. MALZ.SAN. VE TİC. A.Ş.



HAVUZ ÜRÜN KATALOGU POOL PRODUCT CATALOGUE

2023

İÇİNDEKİLER / INDEX

04-05

HAKKIMIZDA
ABOUT US

07-12

HAVUZ POMPALARI
SWIMMING POOL PUMPS

13-26

KUM FİLTRELERİ
SAND FILTERS

27-30

POMPA FİLTRE SETLERİ
PUMP FILTER SETS

31-34

HAVUZ İÇİ AYDINLATMA
UNDERWATER LIGHTS

35-52

HAVUZ İÇİ VE KENAR EKİPMANLARI
POOL BASIN AND SIDE EQUIPMENTS

53-60

HAVUZ İÇİ TEMİZLİK EKİPMANLARI
POOL BASIN AND SIDE EQUIPMENTS

61-76

DEZENFEKSİYON SİSTEMLERİ
DISINFECTION SYSTEMS

77-82

HAVUZ KİMYASALLARI
POOL CHEMICALS

83-90

DİĞER ÜRÜNLER
OTHER PRODUCTS

91-94

TEXPOOL HAVUZ LİNER
TEXPOOL POOL LINER

95-104

HAVUZ CAM MOZAIK TUTAMAK & KAYMAZLAR
POOL GLASS MOSAIC TILES HANDLES & ANTISLIPS

105-112

OLİMPİK HAVUZ MALZEMELERİ
OLYMPIC POOL EQUIPMENTS

113-126

SÜS HAVUZU LAMBA VE FİSKİYELERİ
FOUNTAIN EQUIPMENTS

127-134

SPA ÜRÜNLERİ
SPA PRODUCTS

135-141

SAUNA MALZEMELERİ
SAUNA EQUIPMENTS

PİMTAŞ A.Ş. 1977 yılında kurulmuş olup, üretime başladığı andan itibaren plastik inşaat malzemelerinin (Boru, Ek parça, Küresel Vana, Kelebek Vana, Çekvalf, Rakor, Havuz ve Tesisat teknik ekipmanları) kendine özgü tasarımını ve imalatını yapan, plastik sektöründeki uluslararası öncü kuruluşlardan biridir.

PİMTAŞ A.Ş. kullanmış olduğu üretim teknolojisini geliştirerek mevcut üretimini Batı Avrupa' da kullanılan teknoloji normlarına uyarlamıştır. Üretim programı her türlü inşaat problemini çözecek ek parça ve yardımcı malzemelerini kapsamaktadır. Avrupa ve Gümrük Birliğine geçmiş olmanın bilinci ile teknoloji ve kalitede Avrupa'nın en iyi firmaları ile rekabet eden bir üretim gerçekleştirmektedir.

Bugün Pimtaş Plastik , ISO 9001 kalite yönetim sistemine ve TSE Belgesine sahip olarak en yeni teknolojik altyapı, makine ve kalıp sistemleri ile başta Avrupa ülkeleri başta olmak üzere 105 ayrı ülkeye ihracat yapan ve 81 ilde tüketicinin memnuniyetini ve güvenini kazanmış bir firmadır.

550'yi aşkın tecrübeli çalışanı ile 7/24 hizmet vermektedir. 1977 yılından beri siz değerli müşterilerimize daha kaliteli ürünler ve hizmetler sunabilmek için üretiyor ve her geçen yıl kendini yenilemeye devam ediyor.

Vizyonumuz

Sürekli gelişim hedefi ile sektöründe bir dünya şirketi olmak.

Misyonumuz

Biz, ürettiğimiz ürünlerle insan medeniyetinin alt yapısına hizmet ediyoruz.

Yeryüzünde İnsan hayatına suyun rahat, güvenilir ve standartlara uygun bir şekilde ulaşmasını sağlıyoruz. Ürettiğimiz ürünlerle, insanların temel ihtiyaçlarının karşılanmasından, kaliteli ve konforlu bir yaşamın oluşmasına ve sürdürülmesine kadar tüm yaşam alanlarına destek oluyoruz.

Tarım, Turizm, İnşaat ve altyapı sektörlerindeki müşterilerimizin bize duyduğu güvene; kaliteli, hızlı ve ulaşılabilir plastik boru ve bağlantı ekipmanları üreterek cevap veriyoruz.

PİMTAŞ A.Ş. was established in 1977, and is now one of the leading international companies in the plastic sector that has been designing and manufacturing plastic construction materials (Pipes, Fittings, Ball Valves, Butterfly Valves, Check Valves, Fittings, Pool and Plumbing technical equipment) since the moment it started production.

PİMTAŞ A.Ş. has adapted its current production to the technology standards used in Western Europe by improving its production technology. The production program includes additional parts and auxiliary materials that can solve all kinds of construction problems. With the awareness of being transferred to Europe and the Customs Union, it realizes a production that competes with Europe's best companies in technology and quality.

Today, Pimtaş Plastik is a company that has ISO 9001 quality management system and TSE Certificate and exports to 105 different countries, mostly to European countries, with the latest technological infrastructure, machinery and mold systems, and gained the satisfaction and trust of consumers in 81 provinces. Pimtaş provides 24/7 service with the help of more than 550 experienced employees. It has been producing since 1977 to provide better quality products and services to our valued customers and continues to renew itself every year.

Our Vision

To become a global company in field with the target of constant development.

Our Mission

We serve the infrastructure of human civilization with the products we produce. We ensure that water reaches human life comfortably, reliably and in accordance with the standards. With the products we produce, we support all living spaces, from meeting basic needs to the creation and maintenance of a quality and comfortable life.

The trust of our customers in the agriculture, tourism, construction and infrastructure sectors; We respond by producing high quality, fast and accessible plastic pipes and connection equipment.

PİMTAŞ 1



PİMTAŞ 2



PİMTAŞ 3



PİMTAŞ 4



PİMTAŞ 5



PİMTAŞ 6



PİMTAŞ 7



*Where you are,
pimtaş is there...*



HAVUZ POMPALARI SWIMMING POOL PUMPS



WATER ATLASPOOL SERİSİ



Monofaze Ön Filtreli Plastik Pompalar
Monophase Thermoplastic Pump With Pre-Filter

Malzeme Cinsi Description	Kod Code	Fiyat (Adet) Price (Pcs)	Kg/Adet Kg/Pcs	Koli/Adet Box/Pcs	Debi / Flow (9mss)
0,50 HP Atlaspool Ön Filtreli Pompa (Monofaze) 0,50 HP Atlaspool Monophase Pump with Pre-Filter	ATS WTA001	240,00 €	8,50	1	12 m³/h
0,75 HP Atlaspool Ön Filtreli Pompa (Monofaze) 0,75 HP Atlaspool Monophase Pump with Pre-Filter	ATS WTA002	250,00 €	8,80	1	14 m³/h
1,00 HP Atlaspool Ön Filtreli Pompa (Monofaze) 1,00 HP Atlaspool Monophase Pump with Pre-Filter	ATS WTA003	270,00 €	10,35	1	17 m³/h
1,50 HP Atlaspool Ön Filtreli Pompa (Monofaze) 1,50 HP Atlaspool Monophase Pump with Pre-Filter	ATS WTA004	290,00 €	11,45	1	21 m³/h
2,00 HP Atlaspool Ön Filtreli Pompa (Monofaze) 2,00 HP Atlaspool Monophase Pump with Pre-Filter	ATS WTA005	①	13,75	1	25 m³/h

Trifaze Ön Filtreli Plastik Pompalar
Thermoplastic Pumps With Pre-Filter

Malzeme Cinsi Description	Kod Code	Fiyat (Adet) Price (Pcs)	Kg/Adet Kg/Pcs	Koli/Adet Box/Pcs	Debi / Flow (9mss)
1,00 HP Atlaspool Ön Filtreli Pompa (Trifaze) 1,00 HP Atlaspool Three-phase Pump with Pre-Filter	ATS WTA006	270,00 €	10,35	1	17 m³/h
1,50 HP Atlaspool Ön Filtreli Pompa (Trifaze) 1,50 HP Atlaspool Three-phase Pump with Pre-Filter	ATS WTA007	290,00 €	11,45	1	21 m³/h
2,00 HP Atlaspool Ön Filtreli Pompa (Trifaze) 2,00 HP Atlaspool Three-phase Pump with Pre-Filter	ATS WTA008	①	13,75	1	25 m³/h

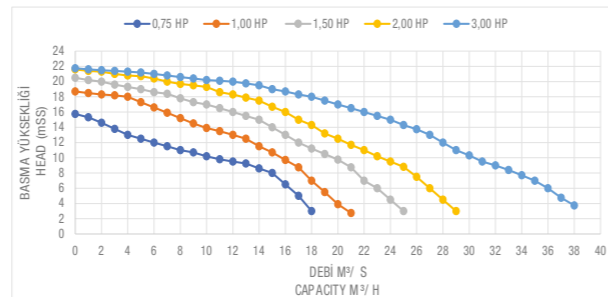
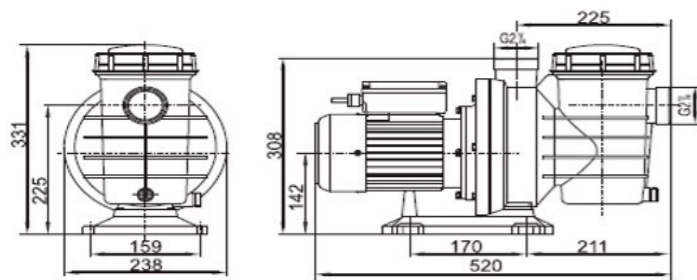

Model	Qmax (l/min)	Hmax (m)	Power(P1)		Power(P2)		Fitting size (mm)
			kW	HP	kW	HP	
WATER ATLAS 0.50	195	7	0.37	0.5	0.25	0.33	48.5or50
WATER ATLAS 0.75	255	10	0.55	0.75	0.37	0.5	
WATER ATLAS 1.00	340	12.5	0.75	1.0	0.55	0.75	
WATER ATLAS 1.50	390	17.5	1.1	1.5	0.75	1.0	

POWER	HEAD (mss)								
	6	8	10	12	14	16	18	20	22
0,75 HP	16	15	11	7	4	1,5			
1,00 HP	19	17,5	16	14	12	10	6		
1,50 HP	23	21,5	20	18	16	14	10		
2,00 HP	27	25	23,5	21	19	17	14	10	3
3,00 HP	35	33	31	29	26	23	17	14	5

BEST MODEL



Monofaze Ön Filtreli Plastik Pompalar
Monophase Thermoplastic Pump With Pre-Filter

Malzeme Cinsi Description	Kod Code	Fiyat (Adet) Price (Pcs)	Kg /Adet Kg/Pcs	Koli/Adet Box/Pcs	Debi / Flow (9mss)
0,75 HP Ön Filtreli Pompa (Monofaze) Best Model 0,75 HP Monophase Pump with Pre-Filter (Best Model)	ATS POM001	370,00 €	19,30	1	14 m³/h
1,00 HP Ön Filtreli Pompa (Monofaze) Best Model 1,00 HP Monophase Pump with Pre-Filter (Best Model)	ATS POM002	400,00 €	20,40	1	17 m³/h
1,50 HP Ön Filtreli Pompa (Monofaze) Best Model 1,50 HP Monophase Pump with Pre-Filter (Best Model)	ATS POM003	440,00 €	23,10	1	21 m³/h
2,00 HP Ön Filtreli Pompa (Monofaze) Best Model 2,00 HP Monophase Pump with Pre-Filter (Best Model)	ATS POM004	480,00 €	25,70	1	25 m³/h
3,00 HP Ön Filtreli Pompa (Monofaze) Best Model 3,00 HP Monophase Pump with Pre-Filter (Best Model)	ATS POM005	530,00 €	26,90	1	32 m³/h

Trifaze Ön Filtreli Plastik Pompalar
Three-phase Thermoplastic Pump With Pre-Filter

Malzeme Cinsi Description	Kod Code	Fiyat (Adet) Price (Pcs)	Kg /Adet Kg/Pcs	Koli/Adet Box/Pcs	Debi / Flow (9mss)
1,00 HP Ön Filtreli Pompa (Trifaze)Best Model 1,00 HP Three-phase Pump with Pre-Filter (Best Model)	ATS POM006	400,00 €	21,00	1	17 m³/h
1,50 HP Three-phase Pump with Pre-Filter (Best Model) 1,50 HP Ön Filtreli Pompa (Trifaze)Best Model	ATS POM007	440,00 €	23,60	1	21 m³/h
2,00 HP Ön Filtreli Pompa (Trifaze)Best Model 2,00 HP Three-phase Pump with Pre-Filter (Best Model)	ATS POM008	480,00 €	26,50	1	25 m³/h
3,00 HP Ön Filtreli Pompa (Trifaze)Best Model 3,00 HP Three-phase Pump with Pre-Filter (Best Model)	ATS POM009	530,00 €	27,00	1	32 m³/h



Trifaze - Monofaze Ön Filtresiz
Three-phase Monophase Thermoplastic Pump Without Pre-Filter

Malzeme Cinsi Description	Kod Code	Fiyat (Adet) Price (Pcs)	Kg /Adet Kg/Pcs	Koli/Adet Box/Pcs	Debi / Flow (9mss)
0,75 HP Ön Filtresiz Pompa (Monofaze) Best Model 0,75 HP Monophase Pump without Pre-Filter (Best Model)	ATS POM010	350,00 €	17,60	1	14 m³/h
1,00 HP Ön Filtresiz Pompa (Monofaze) Best Model 1,00 HP Monophase Pump without Pre-Filter (Best Model)	ATS POM011	375,00 €	18,65	1	17 m³/h
1,50 HP Ön Filtresiz Pompa (Monofaze) Best Model 1,50 HP Monophase Pump without Pre-Filter (Best Model)	ATS POM012	380,00 €	21,05	1	21 m³/h
2,00 HP Ön Filtresiz Pompa (Monofaze) Best Model 2,00 HP Monophase Pump without Pre-Filter (Best Model)	ATS POM013	410,00 €	24,25	1	25 m³/h
3,00 HP Ön Filtresiz Pompa (Monofaze) Best Model 3,00 HP Mono-Three-phase Pump without Pre-Filter	ATS POM014	460,00 €	25,44	1	32 m³/h

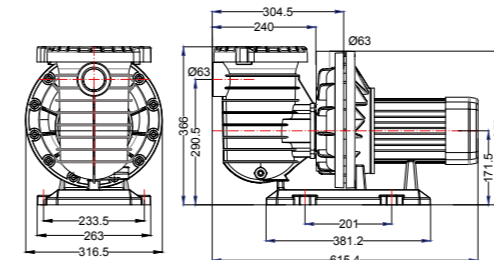

GÜÇ	BASMA YÜKSEKLİĞİ (mss)								
	6	8	10	12	14	16	18	20	22
0,75 HP	16	15	11	7	4	1,5			
1,00 HP	19	17,5	16	14	12	10	6		
1,50 HP	23	21,5	20	18	16	14	10		
2,00 HP	27	25	23,5	21	19	17	14	10	3
3,00 HP	35	33	31	29	26	23	17	14	5

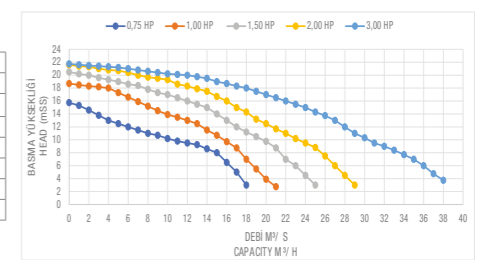

STORM MODEL



Trifaze Ön Filtreli Plastik Pompalar

Thermoplastic Pumps With Pre-Filter

Malzeme Cinsi Description	Kod Code	Fiyat (Adet) Price (Pcs)	Kg /Adet Kg/Pcs	Koli/Adet Box/Pcs	Debi / Flow (9mss)
3.50 HP Storm Ön Filtreli Pompa (Trifaze) 3.50 HP Storm Threephase Pump with Pre-Filter	ATS POM015	700,00 €	33,75	1	64 m³/h
4.50 HP Storm Ön Filtreli Pompa (Trifaze) 4.50 HP Storm Threephase Pump with Pre-Filter	ATS POM016	780,00 €	41,20	1	77 m³/h
5.50 HP Storm Ön Filtreli Pompa (Trifaze) 5.50 HP Storm Threephase Pump with Pre-Filter	ATS POM017	810,00 €	41,50	1	85 m³/h



Trifaze Ön Filtresiz Plastik Pompalar

Thermoplastic Pumps Without Pre-Filter

Malzeme Cinsi Description	Kod Code	Fiyat (Adet) Price (Pcs)	Kg /Adet Kg/Pcs	Koli/Adet Box/Pcs	Debi / Flow (9mss)
3.50 HP Storm Ön Filtresiz Pompa (Trifaze) 3.50 HP Storm Threephase Pump without Pre-Filter	ATS POM018	550,00 €	26,50	1	66 m³/h
4.50 HP Storm Ön Filtresiz Pompa (Trifaze) 3.50 HP Storm Threephase Pump without Pre-Filter	ATS POM019	640,00 €	29,80	1	79 m³/h
5.50 HP Storm Ön Filtresiz Pompa (Trifaze) 3.50 HP Storm Threephase Pump without Pre-Filter	ATS POM020	690,00 €	29,90	1	87 m³/h

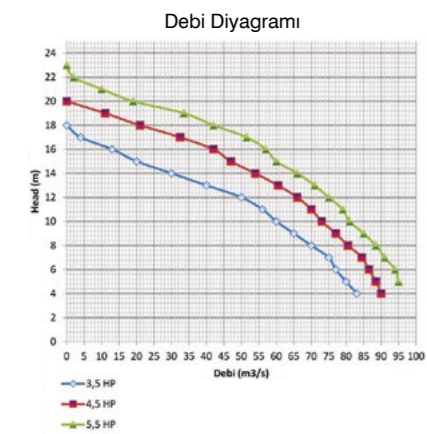

GÜÇ	BASMA YÜKSEKLİĞİ (mss)									
	6	8	10	12	14	16	18	20	22	24
3.50 HP	77	70	61	51	33	15				
4.50 HP	86	80	74	66	54	42	21			
5.50 HP	94	88	81	75	66	56	42	20	4	

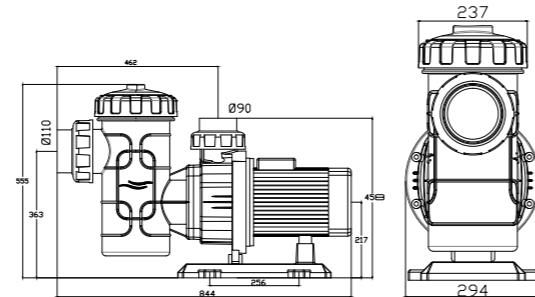

STORM MODEL



Trifaze Ön Filtreli Plastik Pompalar

Thermoplastic Pumps With Pre-Filter

Malzeme Cinsi Description	Kod Code	Fiyat (Adet) Price (Pcs)	Kg /Adet Kg/Pcs	Koli/Adet Box/Pcs	Debi / Flow (9mss)
7.50 HP Storm Ön Filtreli Pompa (Trifaze) 7.50 HP Storm Threephase Pump with Pre-Filter	ATS POM021	1.070,00 €	79,00	1	130 m³/h
10.00 HP Storm Ön Filtreli Pompa (Trifaze) 10.00 HP Storm Threephase Pump with Pre-Filter	ATS POM022	1.250,00 €	86,00	1	145 m³/h
12.50 HP Storm Ön Filtreli Pompa (Trifaze) 12.50 HP Storm Threephase Pump with Pre-Filter	ATS POM063	1.450,00 €	85,00	1	155 m³/h
15.00 HP Storm Ön Filtreli Pompa (Trifaze) 15.00 HP Storm Threephase Pump with Pre-Filter	ATS POM064	1.950,00 €	87,00	1	180 m³/h



Trifaze - Monofaze Ön Filtresiz

Thermoplastic Pumps Without Pre-Filter

Malzeme Cinsi Description	Kod Code	Fiyat (Adet) Price (Pcs)	Kg /Adet Kg/Pcs	Koli/Adet Box/Pcs	Debi / Flow (9mss)
7.50 HP Storm Ön Filtresiz Pompa (Trifaze) 7.50 HP Storm Threephase Pump with Pre-Filter	ATS POM023	970,00 €	79,00	1	130 m³/h
10.00 HP Storm Ön Filtresiz Pompa (Trifaze) 10.00 HP Storm Threephase Pump with Pre-Filter	ATS POM024	1.120,00 €	86,00	1	145 m³/h
12.50 HP Storm Ön Filtresiz Pompa (Trifaze) 12.50 HP Storm Threephase Pump without Pre-Filter	ATS POM065	1.235,00 €	83,00	1	160 m³/h
15.00 HP Storm Ön Filtresiz Pompa (Trifaze) 15.00 HP Storm Threephase Pump without Pre-Filter	ATS POM066	1.985,00 €	85,00	1	190 m³/h

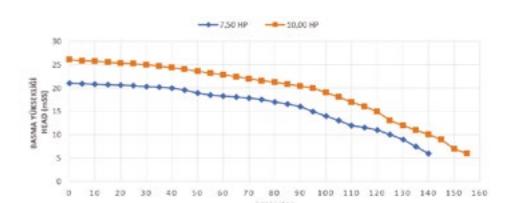
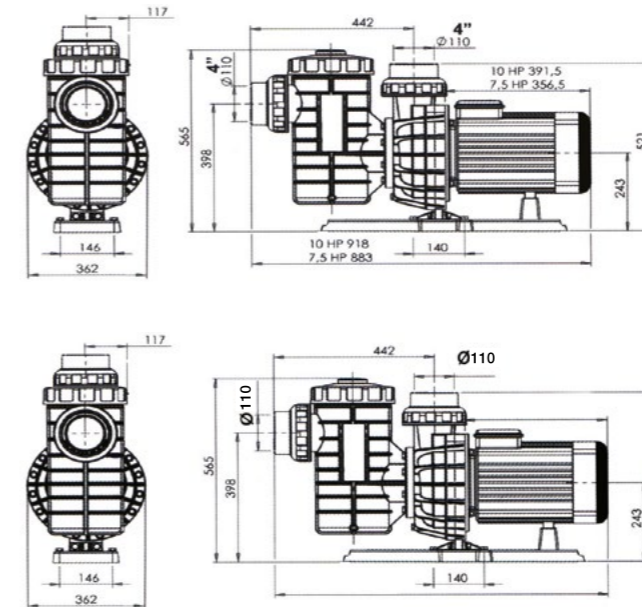

GÜÇ	BASMA YÜKSEKLİĞİ (mss)									
	8	10	12	14	16	18	20	22	24	26
7.50 HP	135	126	113	100	90	76	44			
10,00 HP	148	143	137	126	120	107	97	80	50	

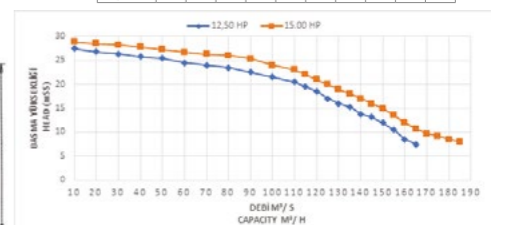

GÜÇ	BASMA YÜKSEKLİĞİ (mss)									
	10	12	14	16	18	20	22	24	26	28
7.50 HP	158	153	147	137	128	116	110	90	60	
10,00 HP	175	166	158	150	138	130	120	110	90	46

POMPA SEHPALARI
PUMP STANDSPolyester Pompa Sehpaası
Polyester Pump Stand

Malzeme Cinsi Description	Kod Code	Fiyat (Adet) Price (Pcs)	Kg /Adet Kg/Pcs	Koli/Adet Box/Pcs
Tekli Polyester Pompa Sehpaası Single Polyester Pump Table	ATS POM038	29,00 €	2,35	1
İkili Polyester Pompa Sehpaası Double Polyester Pump Table	ATS POM039	46,00 €	4,70	1
Üçlü Polyester Pompa Sehpaası Üçlü Polyester Pompa Sehpaası	ATS POM040	58,00 €	12,00	1
Beşli Polyester Pompa Sehpaası Beşli Polyester Pompa Sehpaası	ATS POM041	86,00 €	14,50	1

Pompa Sehpaası (Plastik)
Plastic Pump Stand

Malzeme Cinsi Description	Kod Code	Fiyat (Adet) Price (Pcs)	Kg /Adet Kg/Pcs	Koli/Adet Box/Pcs
Tekli Plastik Pompa Sehpaası Single Plastic Pump Stand	ATS POM067	7,50 €	2,35	1

POMPA KULLANIM ŞEMASI
PUMP USAGE CHART

GÜÇ	EMİŞ HATTI BORU ÇAPI	BASMA HATTI BORU ÇAPI
0,75 HP POMPA	63 mm	63 mm
1 HP POMPA	75 mm	63 mm
1,5 HP POMPA	90 mm	63 mm
2 HP POMPA	90 mm	75 mm
3 HP POMPA	110 mm	90 mm
3,5 HP POMPA	110 mm	90 mm
4,5 HP POMPA	125 mm	110 mm
5,5 HP POMPA	140 mm	110 mm
7,5 HP POMPA	160 mm	125 mm
10 HP POMPA	200 mm	160 mm
12,5 HP POMPA	225 mm	200 mm
15 HP POMPA	250 mm	200 mm

Motor Gücü 0,75 - 1 - 1,5 - 2 - 3 HP	Motor Gücü 1 - 1,5 - 2 - 3 - 3,5 - 4,5 - 5,5 HP	Motor Gücü 7,5 - 10 - 12,5 - 15 HP
Güç Kaynağı 1 faz 220 V	Güç Kaynağı 3 faz 380 V	Güç Kaynağı 3 faz 380 V
Bağlantı (a)	Y - Bağlantı (b)	Y/Δ - Bağlantı (c) (3 sn Y çalışacak sonra Δ'e geçecek)

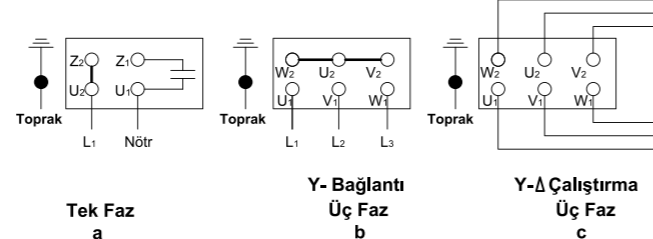
KUM FİLTRELERİ
SAND FILTERS

PLASTİK FİLTRELER (ECOSTAR)
PLASTIC FILTER (ECOSTAR)



3,5 Bar Test Basıncı

Ecostar Plastik Kum Filtreleri
Ecostar Plastic Sand Filter

Ölçü Size	Kod Code	Fiyat (Adet) Price (Pcs)	Kg /Adet Kg/Pcs	Koli/Adet Box/Pcs	Debi 30 m3/h/m2	Debi 40 m3/h/m2	Debi 50 m3/h/m2	Bağlantı Connection
400 mm	ATS PLS 0400	200,00 €	10,45	1	4,00	5,00	6,00	D50
500 mm	ATS PLS 0500	230,00 €	12,95	1	6,00	8,00	10,00	D50
620 mm	ATS PLS 0620	250,00 €	21,00	1	9,00	12,00	15,00	D50
760 mm	ATS PLS 0760	340,00 €	32,00	1	14,00	18,00	22,00	D63
920 mm	ATS PLS 0920	460,00 €	44,50	1	20,00	27,00	33,00	D63
1050 mm	ATS PLS 1050	550,00 €		1	25,00	34,00	43,00	D90

Monoblok polietilen gövde üzerine plastik kum filtresi.

Yandan vana bağlantılı.1050 mm Plastik Filtre için 6 yollu vana dahil değildir.

Monoblock polyethylene body of sand filter is fortified by plastic valve is connected to the side of filter.

Prices include multiport valve, exclude sand. Price of 1050 mm plastic filter exclude multiport valve and sand.

Teknik Özellikleri

Technical Characteristics

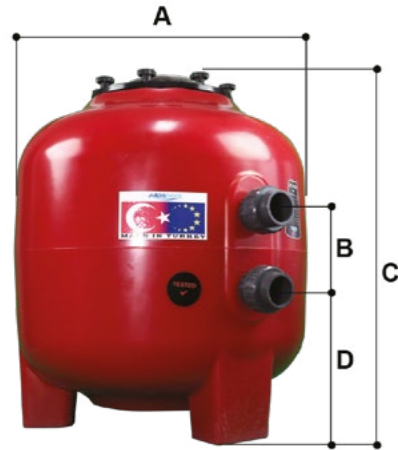

A (cm)	B (cm)	C (cm)	D (cm)	Filtreleme Alanı m2 Filter Bed	0,7 - 1,2 mm İnce Kum Quartz Sand	1,2 - 3,0 mm Orta Kum Quartz Sand	3,0 - 5,0 mm Kalın Kum Quartz Sand	Toplam Kum Miktarı Total Quartz Sand
40	19	58	12,5	0,125	25 kg	25 kg	-	50 kg
50	24,5	68	12,5	0,197	50 kg	25 kg	-	75 kg
62	27,5	77	13,5	0,303	100 kg	50 kg	-	150 kg
76	37	96	16	0,454	200 kg	100 kg	-	300 kg
92	42	107	20	0,665	300 kg	150 kg	-	450 kg
105	47	115	27	0,866	400 kg	200 kg	150 kg	750 kg

CANADA MODEL

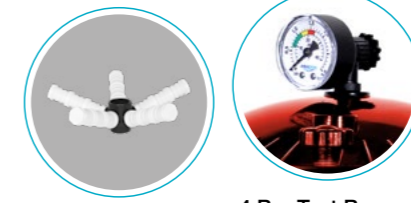

4 Bar Test Basıncı

4 Bar Test Basıncı
Test Pressure 4 Bar

Canada Model
Polyester Sand Filters

Ölçü Size	Kod Code	Fiyat (Adet) Price (Pcs)	Kg /Adet Kg/Pcs	Koli/Adet Box/Pcs	Debi 30 m3/h/m2	Debi 40 m3/h/m2	Debi 50 m3/h/m2	Bağlantı Connection
400 mm	ATS FLT037	280,00 €	13,50	1	4,00	5,00	6,00	D50
500 mm	ATS FLT001	300,00 €	15,50	1	6,00	8,00	10,00	D50
620 mm	ATS FLT002	327,00 €	24,00	1	9,00	12,00	15,00	D50
760 mm	ATS FLT003	430,00 €	35,00	1	14,00	18,00	22,00	D63
800 mm	ATS FLT038	520,00 €	40,00	1	16,00	21,00	25,00	D63
830 mm	ATS FLT039	550,00 €	43,00	1	17,00	22,00	28,00	D63
920 mm	ATS FLT004	610,00 €	44,50	1	20,00	27,00	33,00	D63

Monoblok polyester ve fiberglas gövde üzerine polyester elyaf takviyeli kum filtresi. Yandan vana bağlantılı. Fiyatlara çok yollu vana dahil, kum hariçtir.

The sand filters are manufactured with monobloc polyester resin and fiberglass with boltless lid and polypropylene base. Equipped with pressure gauge, water drainage plug, and multiport valve. Side Model. Prices include multiport valves, exclude sand.

OZONA DAYANIKLI CANADA MODEL ÇİFT KAT POLİVİNİL ESTER KAPLAMA
OZONE RESISTANT FILTER DOUBLE LAYER POLYVINYL ESTER COVERING



4 Bar Test Basıncı
Test Pressure 4 Bar

Ölçü Size	Kod Code	Fiyat (Adet) Price (Pcs)	Kg /Adet Kg/Pcs	Koli/Adet Box/Pcs	Debi 30 m3/h/m2	Debi 40 m3/h/m2	Debi 50 m3/h/m2	Bağlantı Connection
400 mm	ATS FLT037-1	506,00 €	15,50	1	4,00	5,00	6,00	D50
500 mm	ATS FLT001-1	552,00 €	15,50	1	6,00	8,00	10,00	D50
620 mm	ATS FLT002-1	655,00 €	24,00	1	9,00	12,00	15,00	D50
760 mm	ATS FLT003-1	920,00 €	35,00	1	14,00	18,00	22,00	D63
800 mm	ATS FLT038-1	990,00 €	40,00	1	16,00	21,00	25,00	D63
830 mm	ATS FLT039-1	1.010,00 €	43,00	1	17,00	22,00	28,00	D63
920 mm	ATS FLT004-1	1.150,00 €	44,50	1	20,00	27,00	33,00	D63

Monoblok polyester ve fiberglas gövde üzerine polyester elyaf takviyeli kum filtresi. Yandan vana bağlantılı. Fiyatlara çok yollu vana dahil, kum hariçtir.

The sand filters are manufactured with monobloc polyester resin and fiberglass with boltless lid and polypropylene base. Equipped with pressure gauge, water drainage plug, and multiport valve. Side Model. Prices exclude multiport valves and sand.

CANADA MODEL TİCARİ TİP CANADA MODEL COMMERCIAL TYPE

FİLTRE
FILTER

Ø1050 - Ø1250

Ø1400 - Ø1600 - Ø2000 - Ø2350

4 Bar Test Basıncı
Test Pressure 4 Bar

Polyester Kum Filtreleri, Ticari Tip (Flaş Bağ.)

Fiberglass / Polyester Sand Filter, Commercial Type (Flange Connection)

Ölçü Size	Kod Code	Fiyat (Adet) Price (Pcs)	Kg /Adet Kg/Pcs	Koli/Adet Box/Pcs	Debi 30 m3/h/m2	Debi 40 m3/h/m2	Debi 50 m3/h/m2	Bağlantı Connection
1050 mm	ATS FLT005	800,00 €	80,00	1	25	34	43	D90
1250 mm	ATS FLT006	950,00 €	130,00	1	36	48	61	D90
1400 mm	ATS FLT007	1.400,00 €	195,00	1	46	62	77	D110
1600 mm	ATS FLT008	1.750,00 €	230,00	1	60	80	100	D110
2000 mm	ATS FLT009	3.000,00 €	320,00	1	94	126	157	D160
2350 mm	ATS FLT040	5.350,00 €		1	130	173	217	D200

Monoblok polyester ve fibreglas gövde üzerine polyester elyaf takviyeli kum filtresi. Yandan vana bağlantılı. Fiyatlara Ø 2000 - Ø 2350 çiftli manometre seti dahil, çok yollu vana ve kum dahil değildir.

The sand filters are manufactured with monobloc polyester resin and fibreglass with bottless lid and polypropylene base. Equipped with pressure gauge, water drainage plug, and multiport valve. Side Model. Prices exclude multiport valves and sand.

Tablalı Polyester Kum Filtreleri, Ticari Tip (Flaş Bağ.)

Nozzle Distribution System + Flanged Connection

Tablalı Mantar Fiskiye Sistemi
Nozzle Distribution System4 Bar Test Basıncı
Test Pressure 4 Bar

Ölçü Size	Kod Code	Fiyat (Adet) Price (Pcs)	Kg /Adet Kg/Pcs	Koli/Adet Box/Pcs	Debi 30 m3/h/m2	Debi 40 m3/h/m2	Debi 50 m3/h/m2	Bağlantı Connection
2000 mm	ATS FLT009-M	6.550,00 €	320,00	1	94	126	157	D160
2350 mm	ATS FLT040-M	10.900,00 €		1	130	173	217	D200

Monoblok polyester ve fibreglas gövde üzerine polyester elyaf takviyeli kum filtresi. Yandan vana bağlantılı. Fiyatlara Ø 2000 - Ø 2350 çiftli manometre seti dahil, çok yollu vana ve kum dahil değildir.

Sand Filter is manufactured with monobloc polyester and fibreglass body reinforced with polyester fiber. Side valve connection. Prices include Ø 2000 - Ø 2350 double manometer set. Multi-way valve and sand are not included.

CANADA MODEL OZONA DAYANIKLI ÇİFT KAT POLİVİNİL ESTER KAPLAMA OZONE RESISTANT FILTER DOUBLE LAYER POLYVINYL ESTER COVERING

FİLTRE
FILTER

Ø1050 - Ø1250

Ø1400 - Ø1600 - Ø2000 - Ø2350

4 Bar Test Basıncı
Test Pressure 4 Bar

Polyester Kum Filtreleri, Ticari Tip (Flaş Bağ.)

Double Layer Polyvinyl Ester Covering + Flanged Connection

Ölçü Size	Kod Code	Fiyat (Adet) Price (Pcs)	Kg /Adet Kg/Pcs	Koli/Adet Box/Pcs	Debi 30 m3/h/m2	Debi 40 m3/h/m2	Debi 50 m3/h/m2	Bağlantı Connection
1050 mm	ATS FLT005-1	1.610,00 €	80,00	1	25	34	43	D90
1250 mm	ATS FLT006-1	2.070,00 €	130,00	1	36	48	61	D90
1400 mm	ATS FLT007-1	2.950,00 €	195,00	1	46	62	77	D110
1600 mm	ATS FLT008-1	3.650,00 €	230,00	1	60	80	100	D110
2000 mm	ATS FLT009-1	6.550,00 €	320,00	1	94	126	157	D160
2350 mm	ATS FLT040-1	10.950,00 €		1	130	173	217	D200

Monoblok polyester ve fibreglas gövde üzerine polyester elyaf takviyeli kum filtresi. Yandan vana bağlantılı. Fiyatlara Ø 2000 - Ø 2350 çiftli manometre seti dahil, çok yollu vana ve kum dahil değildir.

Sand Filter is manufactured with monobloc polyester and fibreglass body reinforced with polyester fiber. Side valve connection. Prices include Ø 2000 - Ø 2350 double manometer set. Multi-way valve and sand are not included.

Tablalı Polyester Kum Filtreleri, Ticari Tip (Flaş Bağ.)

Nozzle Distribution System + Flanged Connection

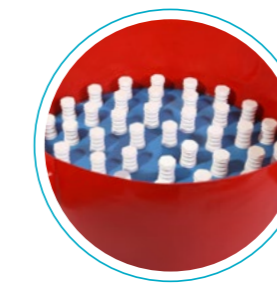
Tablalı Mantar Fiskiye Sistemi
Nozzle Distribution System4 Bar Test Basıncı
Test Pressure 4 Bar

Ölçü Size	Kod Code	Fiyat (Adet) Price (Pcs)	Kg /Adet Kg/Pcs	Koli/Adet Box/Pcs	Debi 30 m3/h/m2	Debi 40 m3/h/m2	Debi 50 m3/h/m2	Bağlantı Connection
2000 mm	ATS FLT009-M1	①	320,00	1	94	126	157	D160
2350 mm	ATS FLT040-M1	①		1	130	173	217	D200

Monoblok polyester ve fibreglas gövde üzerine polyester elyaf takviyeli kum filtresi. Yandan vana bağlantılı. Fiyatlara Ø 2000 - Ø 2350 çiftli manometre seti dahil, çok yollu vana ve kum dahil değildir.

Sand Filter is manufactured with monobloc polyester and fibreglass body reinforced with polyester fiber. Side valve connection. Prices include Ø 2000 - Ø 2350 double manometer set. Multi-way valve and sand are not included.

Çiftli Manometre Seti
Double Sided Manometer Set



Malzeme Cinsi Description	Kod Code	Fiyat (Adet) Price (Pcs)
Çiftli Manometre Seti Double Sided Manometer Set	ATS FLT048	290,00 €

- İki ayrı gliserinli hassas manometre
- Geniş manometre kadranı
- Çift taraflı hava purjörü ve açma kapama vanaları
- Precision manometer with two separate glycerin
- Wide manometer screen
- Double sided air vent and on-off valves.

Canada Model Kum Filtreleri Teknik Özellikleri
Canada Model Sand Filter Technical Characteristics

A (cm)	B (cm)	C (cm)	D (cm)	Filtreleme Alanı Filter Bed m ²	0,7 - 1,2 mm İnce Kum Quartz Sand (kg)	1,2 - 3,0 mm Orta Kum Quartz Sand (kg)	3,0 - 5,0 mm Kalın Kum Quartz Sand (kg)	Toplam Kum Miktarı Total Quartz Sand(kg)
40	20	65	12	0,125	25	25	-	50
50	22	70	12	0,197	50	25	-	75
62	25	79	13	0,303	100	50	-	150
76	26	92,5	17	0,454	200	100	-	300
80	27	95,5	18	0,502	225	100	-	325
83	28	98	18	0,540	225	125	-	350
92	31,5	103,5	20	0,665	300	150	-	450
105	45	115	19,5	0,866	400	200	150	750
125	52	143		1,227	500	200	200	900
140	66	160		1,099	625	625	550	1800
160	70,5	185		2,000	1550	1000	950	2500
200	85	203		3,141	1700	1300	1000	4000
235				4,334	3500	3500	1300	8300

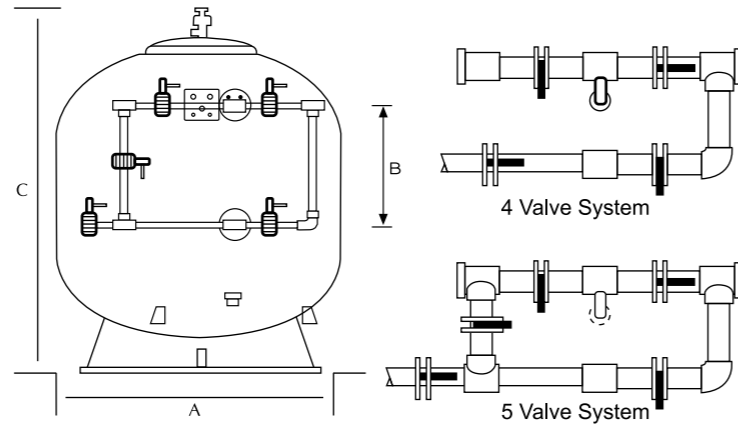
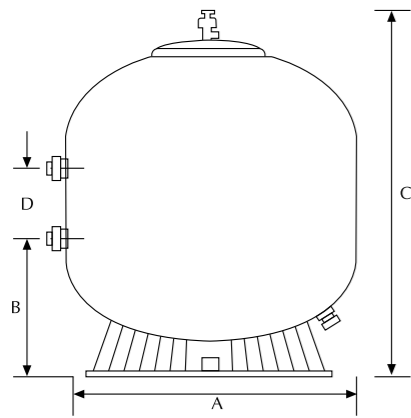

ÜSTTEN VANALI PLASTİK FİLTRELER
TOP MOUNTED PLASTIC FILTER

Ecostar Plastik Kum Filtreleri
Ecostar Plastic Filter



Ölçü Size	Kod Code	Fiyat (Adet) Price (Pcs)	Kg /Adet Kg/Pcs	Koli/Adet Box/Pcs	Debi 30 m3/h/m2	Debi 40 m3/h/m2	Debi 50 m3/h/m2	Bağlantı Connection
400 mm	ATS PLS 0400-1	230,00 €	10,45	1	4,00	5,00	6,00	D50
500 mm	ATS PLS 0500-1	255,00 €	12,95	1	6,00	8,00	10,00	D50
620 mm	ATS PLS 0620-1	300,00 €	21,00	1	9,00	12,00	15,00	D50
760 mm	ATS PLS 0760-1	410,00 €	32,00	1	14,00	18,00	22,00	D63
920 mm	ATS PLS 0920-1	580,00 €	44,50	1	20,00	27,00	33,00	D63

Monoblok polietilen gövde üzerine plastik kum filtresi. Üstten vana bağlantılı.

The sand filters are manufactured with monobloc polyester resin and fibreglass with boltless lid and polypropylene base. Equipped with pressure gauge, water drainage plug, and multiport valve. Top Mounted Model prices include multiport valves, exclude sand.



Teknik Özellikleri
Technical Characteristics

A (cm)	B (cm)	C (cm)	Filtreleme Alanı Filter Bed m2	0,7 - 1,2 mm İnce Kum Quartz Sand (kg)	1,2 - 3,0 mm Orta Kum Quartz Sand (kg)	3,0 - 5,0 mm Kalın Kum Quartz Sand (kg)	Toplam Kum Miktarı Total Quartz Sand(kg)
46	66,5	40	0,125	25	25	-	50
56,5	77,5	50	0,197	50	25	-	75
64	85	62	0,303	100	50	-	150
80	106	76	0,454	200	100	-	300
93	119	92	0,665	300	150	-	450

ÜSTTEN VANALI CANADA MODEL
TOP MOUNTED CANADA MODEL

Polyester Kum Filtreleri
Top Mounted Polyester Filter



Ölçü Size	Kod Code	Fiyat (Adet) Price (Pcs)	Kg /Adet Kg/Pcs	Koli/Adet Box/Pcs	Filtre Hızı (m3/h)	Bağlantı Connection
400 mm	ATS FLT041	325,00 €	15,00	1	6,00	D50
500 mm	ATS FLT042	345,00 €	20,00	1	10,00	D50
620 mm	ATS FLT043	410,00 €	31,00	1	15,00	D50
760 mm	ATS FLT044	560,00 €	38,00	1	22,00	D63
800 mm	ATS FLT045	595,00 €	40,00	1	25,00	D63
830 mm	ATS FLT046	630,00 €	42,00	1	28,00	D63
920 mm	ATS FLT047	725,00 €	44,50	1	33,00	D63

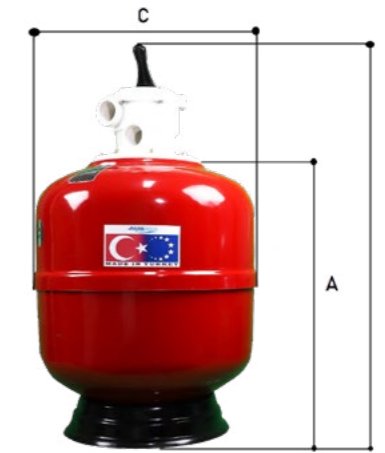

Teknik Özellikleri
Technical Characteristics

A (cm)	B (cm)	C (cm)	Filtreleme Alanı m2	İnce Kum (kg)	Orta Kum (kg)	Kalın Kum (kg)	Toplam Kum Miktarı (kg)
52	73	40	0,125	25	25	-	50
58	79	50	0,197	50	25	-	75
67	88	62	0,303	100	50	-	150
80,5	110	76	0,454	200	100	-	300
83,5	113	80	0,502	225	100	-	325
86	115,5	83	0,540	225	125	-	350
91,5	121	92	0,665	300	150	-	450

DIN NORMU KUM FİLTRELERİ
DIN NORM COMMERCIAL SAND FILTER

DIN Norm Model Kum Filtreleri
DIN Norm Model Sand Filter



Ölçü Size	Kod Code	Fiyat (Adet) Price (Pcs)	Kg /Adet Kg/Pcs	Koli/Adet Box/Pcs
620 mm	ATS ÇKTFLT620	630,00 €	37,00	1
760 mm	ATS ÇKTFLT800	750,00 €	65,00	1
920 mm	ATS ÇKTFLT920	950,00 €	85,00	1
1050 mm	ATS ÇKTFLT1050	1.250,00 €		1
1250 mm	ATS ÇKTFLT1250	1.700,00 €		1

CTP' den Mamul: Çok yollu vanası, bağlantı parçaları, manometre ve pürjörü ile komple.
İç Yapısı: Tablasız ahtapot fiskiyeli. İki yıl garanti.

- 1,2 m Kum yatak yüksekliği
- Çalışma basıncı max. 2 BAR, Test basıncı 4 BAR
- Hava tahliye ve manometreli
- Contalar EPDM civatalar PASLANMAZ
- Gözetleme camlı
- (500-920) Üst kapak ve Menhol kapağı Çapı DN 220
- 1050 -1250 Üst kapak; cam elyaf takviyeli pp DN 395

Made of CTP: Including multi part for (620, 800, 920) value fittings manometer and purger.
International Structure: Tabless octopus system.

- Filtration Depth: 1,2 mt
- Test Pressure: 4 bar
- Working Pressure: Max. 2 bar
- Manometer and air discharge
- EPDM gasket, SS Screw
- Inspection Glass



Teknik Özellikleri
Technical Characteristics

D	H1	H2	H3	H4	H5	H6	H7	Debi		Bağlantı		Anrasit 0,8-1,6 mm (lt)	Kuars Kum 0,5-1 mm (lt)	Kuars Kum 1-3 mm (kg)
								30 m3/h/m2	40 m3/h/m2	Ø	DN			
620	196	190	60	17	32	134	126	9	12	50	40	200	200	150
800	198,5	192,5	80	17	35	137	131	15	20	63	50	275	275	200
920	213	207	98	21	55	157	124	20	26,5	63	50	425	400	375
1050								26	34	90	80	550	450	275
1050								36	48	90	80	725	675	500

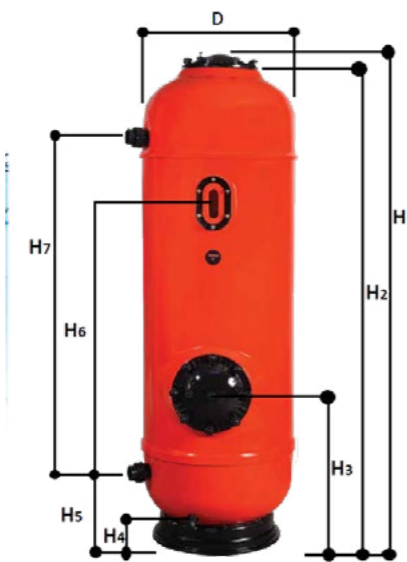

DIN NORMU KUM FİLTRELERİ
DIN NORM COMMERCIAL SAND FILTER

Tablalı DIN Norm Model Kum Filtreleri
DIN Norm Model Sand Filter Nozzle Distribution System



Ölçü Size	Kod Code	Fiyat (Adet) Price (Pcs)	Kg /Adet Kg/Pcs	Koli/Adet Box/Pcs
620 mm	ATS ÇKTFLT620-M	1.150,00 €	37,00	1
760 mm	ATS ÇKTFLT800-M	1.430,00 €	65,00	1
920 mm	ATS ÇKTFLT920-M	1.800,00 €	85,00	1
1050 mm	ATS ÇKTFLT1050-M	2.400,00 €		1
1250 mm	ATS ÇKTFLT1250-M	3.200,00 €		1

CTP' den Mamul: Çok yollu vanası, bağlantı parçaları, manometre ve pürjörü ile komple.
İç Yapısı: Tablalı mantar fiskiye sistemi. İki yıl garanti.

- 1,2 m Kum yatak yüksekliği
- Çalışma basıncı max. 2 BAR, Test basıncı 4 BAR
- Hava tahliye ve manometreli
- Contalar EPDM civatalar PASLANMAZ
- Gözetleme camlı
- (500-920) Üst kapak ve Menhol kapağı Çapı DN 220
- 1050 -1250 Üst kapak; cam elyaf takviyeli pp DN 395

Made of CTP: Including multi part for (620, 800, 920) value fittings, manometer and purger.
International Structure: Tabless octopus system.

- Filtration Depth: 1,2 mt
- Test Pressure: 4 bar
- Working Pressure: Max. 2 bar
- Manometer and air discharge
- EPDM gasket, SS Screw
- Inspection Glass



Tablalı Mantar Fiskiye Sistemi
Nozzle Distribution System

Teknik Özellikleri
Technical Characteristics

D	H1	H2	H3	H4	H5	H6	H7	Debi		Bağlantı		Anrasit 0,8-1,6 mm (lt)	Kuars Kum 0,5-1 mm (lt)	Kuars Kum 1-3 mm (kg)
								30 m3/h/m2	40 m3/h/m2	Ø	DN			
620	196	190	60	17	32	134	126	9	12	50	40	200	200	150
800	198,5	192,5	80	17	35	137	131	15	20	63	50	275	275	200
920	213	207	98	21	55	157	124	20	26,5	63	50	425	400	375
1050								26	34	90	80	550	450	275
1050								36	48	90	80	725	675	500

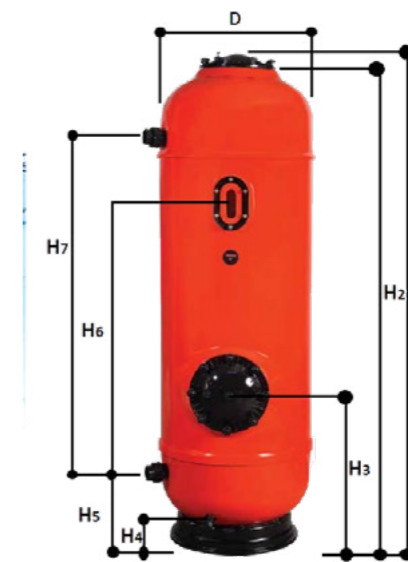

DIN NORMU KUM FİLTRELERİ OZONA DAYANIKLI ÇİFT KAT POLİVİNİL ESTER KAPLAMA
DIN NORM COMMERCIAL SAND FILTER DOUBLE POLYVINY ESTER COVER

DIN Norm Model Kum Filtrleri
DIN Norm Model Sand Filter



Ölçü Size	Kod Code	Fiyat (Adet) Price (Pcs)	Kg /Adet Kg/Pcs	Koli/Adet Box/Pcs
620 mm	ATS ÇKTFLT620-1	1.350,00 €	37,00	1
760 mm	ATS ÇKTFLT800-1	1.400,00 €	65,00	1
920 mm	ATS ÇKTFLT920-1	1.800,00 €	85,00	1
1050 mm	ATS ÇKTFLT1050-1	2.400,00 €		1
1250 mm	ATS ÇKTFLT1250-1	3.300,00 €		1

CTP' den Mamul: Çok yollu vanası, bağlantı parçaları, manometre ve pürjörü ile komple.
 İç Yapısı: Tablasız ahtapot fiskiyeli. İki yıl garanti.

- 1,2 m Kum yatak yüksekliği
- Çalışma basıncı max. 2 BAR, Test basıncı 4 BAR
- Hava tahliye ve manometreli
- Contalar EPDM civatalar PASLANMAZ
- Gözetleme camlı
- (500-920) Üst kapak ve Menhol kapağı Çapı DN 220
- 1050 -1250 Üst kapak; cam elyaf takviyeli pp DN 395

Made of CTP: Including multi part value fittings, manometer and purger.
 International Structure: Tabless octopus system.

- Filtration Depth: 1,2 mt
- Test Pressure: 4 bar
- Working Pressure: Max. 2 bar
- Manometer and air discharge
- EPDM gasket, SS Screw
- Inspection Glass

Teknik Özellikleri
Technical Characteristics

D	H1	H2	H3	H4	H5	H6	H7	Debi		Bağlantı		Anrasit 0,8-1,6 mm (lt)	Kuars Kum 0,5-1 mm (lt)	Kuars Kum 1-3 mm (kg)
								30 m3/h/m2	40 m3/h/m2	Ø	DN			
620	196	190	60	17	32	134	126	9	12	50	40	200	200	150
800	198,5	192,5	80	17	35	137	131	15	20	63	50	275	275	200
920	213	207	98	21	55	157	124	20	26,5	63	50	425	400	375
1050								26	34	90	80	550	450	275
1050								36	48	90	80	725	675	500

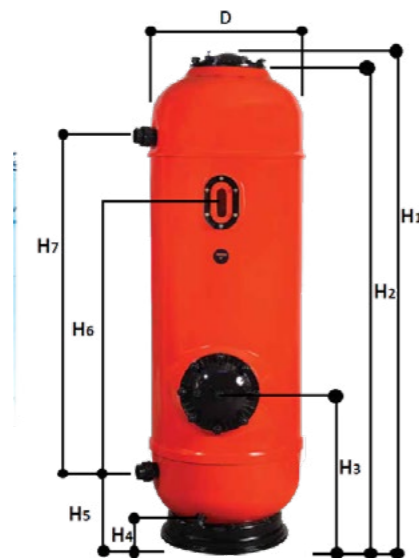

DIN NORMU KUM FİLTRELERİ OZONA DAYANIKLI ÇİFT KAT POLİVİNİL ESTER KAPLAMA
DIN NORM COMMERCIAL SAND FILTER NOZZLE SYSTEM OZONE RESISTANT DOUBLE POLYVINY ESTER COVER

Tablalı DIN Norm Model Kum Filtrleri
DIN Norm Model Sand Filter Nozzle Distribution System



Ölçü Size	Kod Code	Fiyat (Adet) Price (Pcs)	Kg /Adet Kg/Pcs	Koli/Adet Box/Pcs
620 mm	ATS ÇKTFLT620-M1	1.850,00 €	37,00	1
760 mm	ATS ÇKTFLT800-M1	1.940,00 €	65,00	1
920 mm	ATS ÇKTFLT920-M1	2.400,00 €	85,00	1
1050 mm	ATS ÇKTFLT1050-M1	3.350,00 €		1
1250 mm	ATS ÇKTFLT1250-M1	4.300,00 €		1

CTP' den Mamul: Çok yollu vanası, bağlantı parçaları, manometre ve pürjörü ile komple.
 İç Yapısı: Tablalı mantar fiskiye sistemi. İki yıl garanti.

- 1,2 m Kum yatak yüksekliği
- Çalışma basıncı max. 2 BAR, Test basıncı 4 BAR
- Hava tahliye ve manometreli
- Contalar EPDM civatalar PASLANMAZ
- Gözetleme camlı
- (500-920) Üst kapak ve Menhol kapağı Çapı DN 220
- 1050 -1250 Üst kapak; cam elyaf takviyeli pp DN 395

Made of CTP: Including multi part for (620, 800, 920) value fittings, manometer and purger.
 International Structure: Tabless octopus system.

- Filtration Depth: 1,2 mt
- Test Pressure: 4 bar
- Working Pressure: Max. 2 bar
- Manometer and air discharge
- EPDM gasket, SS Screw
- Inspection Glass

Tablalı Mantar Fiskiye Sistemi
 Nozzle Distribution System

Teknik Özellikleri
Technical Characteristics

D	H1	H2	H3	H4	H5	H6	H7	Debi		Bağlantı		Anrasit 0,8-1,6 mm (lt)	Kuars Kum 0,5-1 mm (lt)	Kuars Kum 1-3 mm (kg)
								30 m3/h/m2	40 m3/h/m2	Ø	DN			
620	196	190	60	17	32	134	126	9	12	50	40	200	200	150
800	198,5	192,5	80	17	35	137	131	15	20	63	50	275	275	200
920	213	207	98	21	55	157	124	20	26,5	63	50	425	400	375
1050								26	34	90	80	550	450	275
1050								36	48	90	80	725	675	500

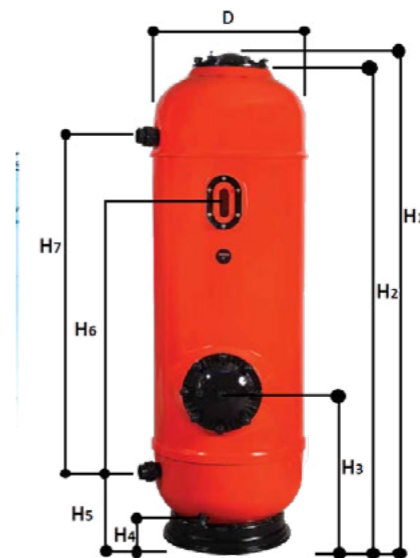

ABS Çok Yollu Vanalar
ABS Multi Port Valve



Malzeme Cinsi Description	Kod Code	Fiyat (Adet) Price (Pcs)	Kg /Adet Kg/Pcs	Koli/Adet Box/Pcs
50-1 1/2" Çok Yollu Vana Side Mount Multiport Valve Glued	ATS FLT022	80,00 €	1,60	1
63-2" Çok Yollu Vana Side Mount Multiport Valve Glued	ATS FLT023	90,00 €	3,00	1
63-2" Çok Yollu Vana - Dişli Side Mount Multiport Valve-Threaded	ATS FLT024	95,00 €	3,00	1
75-2 1/2" Çok Yollu Vana - Dişli - Yap. Side Mount Multiport Valve-Threaded-Glued	ATS FLT025	300,00 €	7,00	1
90 - 3" Çok Yollu Vana - Dişli - Yap. Side Mount Multiport Valve-Threaded-Glued	ATS FLT026	600,00 €	8,00	1
110 - 4" Çok Yollu Vana - Dişli Side Mount Multiport Valve-Threaded	ATS FLT027	4.000,00 €	18,00	1

Kuvars Filtre Kumu
Quartz Sand



Malzeme Cinsi Description	Kod Code	Fiyat (Adet) Price (Pcs)	Kg /Adet Kg/Pcs	Koli/Adet Box/Pcs
Kuvars Kumu 0,7 - 1,5 mm (ince) Quartz Sand 0,7 - 1,5 mm	ATS FLT028	0,30 €	25	1
Kuvars Kumu 1,5 - 3,0 mm (orta) Quartz Sand 1,5 - 3,0 mm	ATS FLT029	0,30 €	25	1
Kuvars Kumu 3,0 - 5,0 mm (kalın) Quartz Sand 3,0 - 5,0 mm	ATS FLT030	0,30 €	25	1

Yedek Parçalar
Spare Parts



Malzeme Cinsi Description	Kod Code	Fiyat (Adet) Price (Pcs)	Koli/Adet Box/Pcs
Manometre 3 bar 3 Bar Gauge	ATS FLT031	10,00 €	1
Manometre 6 bar 6 Bar Gauge	ATS FLT032	15,00 €	1
Hava Purjörü Air Vent	ATS FLT033	3,00 €	1
Filtre Kapağı (500-920) Filtre Lid (500-920)	ATS FLT034	15,00 €	1
Filtre Kapak O-Ringi Filtre Lid O-Ringi	ATS FLT035	6,00 €	1
Plastik Manometre Tasfiye Kiti Plastic Manometer Purge Kit	ATS FLT036	8,00 €	1
Filtre Kapağı (1050 - 2350) Filter Cover (1050 - 2350)	ATS FLT037	150,00 €	1

POMPA FİLTRE SETLERİ

PUMP FILTER SETS



POMPA FİLTRE SETLERİ YANDAN VANALI
PUMP FILTER SETS VALVE FROM SIDE
Polyester Pompa Filtre Setleri
 Polyester Pump Filter Sets

Malzeme Cinsi Description	Kod Code	Fiyat (Adet) Price (Pcs)	Kg /Adet Kg/Pcs	Koli/Adet Box/Pcs	Debi (m³/saat) 50 m³/h/m²	Bağlantı Connection
400 mm Polyester Filtre 0,50 HP	ATS SET 01	①	22,50	1	6,00	D50
500 mm Polyester Filtre 0,75 HP	ATS SET 02	①	26,60	1	10,00	D50
620 mm Polyester Filtre 1,00 HP	ATS SET 03	①	36,75	1	15,00	D50

Plastik Pompa Filtre Setleri
 Plastic Pump Filter Sets



Malzeme Cinsi Description	Kod Code	Fiyat (Adet) Price (Pcs)	Kg /Adet Kg/Pcs	Koli/Adet Box/Pcs	Debi (m³/saat) 50 m³/h/m²	Bağlantı Connection
400 mm Plastik Filtre 0,50 HP	ATS SET 04	①	20,45	1	6,00	D50
500 mm Plastik Filtre 0,75 HP	ATS SET 05	①	23,75	1	10,00	D50
620 mm Plastik Filtre 1,00 HP	ATS SET 06	①	33,35	1	15,00	D50

POMPA FİLTRE SETLERİ ÜSTTEN VANALI
PUMP FILTER SETS VALVE FROM TOP
Polyester Pompa Filtre Setleri
 Polyester Pump Filter Sets

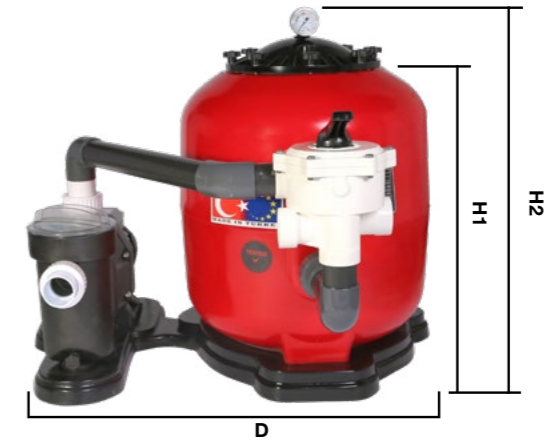

Malzeme Cinsi Description	Kod Code	Fiyat (Adet) Price (Pcs)	Kg /Adet Kg/Pcs	Koli/Adet Box/Pcs	Debi (m³/saat) 50 m³/h/m²	Bağlantı Connection
400 mm Polyester Filtre 0,50 HP	ATS SET 07	①	25,00	1	6,00	D50
500 mm Polyester Filtre 0,75 HP	ATS SET 08	①	30,80	1	10,00	D50
620 mm Polyester Filtre 1,00 HP	ATS SET 09	①	43,35	1	15,00	D50

Plastik Pompa Filtre Setleri
 Plastic Pump Filter Sets

Malzeme Cinsi Description	Kod Code	Fiyat (Adet) Price (Pcs)	Kg /Adet Kg/Pcs	Koli/Adet Box/Pcs	Debi (m³/saat) 50 m³/h/m²	Bağlantı Connection
400 mm Plastik Filtre 0,50 HP	ATS SET 10	①	23,00	1	6,00	D50
500 mm Plastik Filtre 0,75 HP	ATS SET 11	①	27,50	1	10,00	D50
620 mm Plastik Filtre 1,00 HP	ATS SET 12	①	41,00	1	15,00	D50

POMPA FİLTRE SETLERİ TEKNİK ÖZELLİKLERİ
PUMP FILTER SETS TECHNICAL SPECIFICATIONS

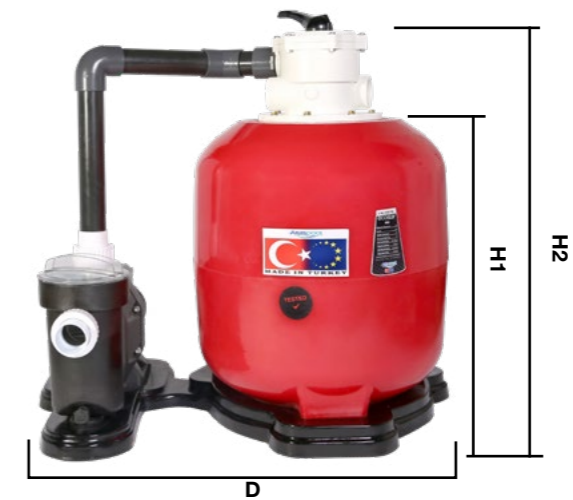
YANDAN VANALI TEKNİK ÖZELLİKLERİ
VALVE FROM SIDE SPECIFICATIONS

Kod Code	H1 (cm)	H2 (cm)	D (cm)	Filtreleme Alanı m2	İnce Kum (kg)	Orta Kum (kg)	Kalın Kum (kg)	Toplam Kum Miktarı (kg)
ATS SET 01	52	66	66	0,125	25	25	-	50
ATS SET 02	58	71	77	0,197	50	25	-	75
ATS SET 03	67	80	88	0,303	100	50	-	150
ATS SET 04	47	59	78	0,125	25	25	-	50
ATS SET 05	57	69	84	0,197	50	25	-	75
ATS SET 06	66	78	96	0,303	100	50	-	150

ÜSTTEN VANALI TEKNİK ÖZELLİKLERİ
VALVE FROM TOP SPECIFICATIONS

Kod Code	H1 (cm)	H2 (cm)	D (cm)	Filtreleme Alanı m2	İnce Kum (kg)	Orta Kum (kg)	Kalın Kum (kg)	Toplam Kum Miktarı (kg)
ATS SET 07	52	74	66	0,125	25	25	-	50
ATS SET 07	58	80	77	0,197	50	25	-	75
ATS SET 09	67	89	88	0,303	100	50	-	150
ATS SET 10	47	69	78	0,125	25	25	-	50
ATS SET 11	57	79	84	0,197	50	25	-	75
ATS SET 12	66	88	96	0,303	100	50	-	150

Not / Note

HAVUZ İÇİ AYDINLATMA UNDERWATER LIGHTS



Ekonomik Model Plastik Gövdeli 25W/12V Kovanlı Lamba (Ledli)

Economic Led Light With Niche (Plastic Body) 18-25W/12V



Malzeme Cinsi Description	Kod Code	Fiyat (Adet) Price (Pcs)	Kg /Adet Kg/Pcs	Koli/Adet Box/Pcs	Güç(W)
Ledli Kovanlı Beyaz / Eco Led Light with Niche-White	ATS HIA006-1	60,00 €	1,55	1	25
Ledli Kovanlı Günışığı / Eco Led Light with Niche-Daylight	ATS HIA007-1	60,00 €	1,55	1	25
Ledli Kovanlı Mavi / Eco Led Light with Niche-Blue	ATS HIA008-1	60,00 €	1,55	1	25
RGB 2 Kablo / Eco Led Light with Niche-RGB 2 Cable	ATS HIA009-1	95,00 €	1,55	1	18
RGB 4 Kablo / Eco Led Light with Niche-RGB 4 Cable	ATS HIA010-1	95,00 €	1,55	1	18

Alüminyum Gövde Su Soğutmalı 30W/12V Kovanlı Lamba (Ledli)

Led Light With Niche (Aluminium Body) 30W/12V



Malzeme Cinsi Description	Kod Code	Fiyat (Adet) Price (Pcs)	Kg /Adet Kg/Pcs	Koli/Adet Box/Pcs	Güç(W)
Ledli Kovanlı Lamba - Beyaz / Led Light with Niche-White	ATS HIA006	90,00 €	2,60	1	30
Ledli Kovanlı Lamba - Günışığı / Led Light with Niche-Daylight	ATS HIA007	90,00 €	2,60	1	30
Ledli Kovanlı Lamba - Mavi / Eco Led Light with Niche-Blue	ATS HIA008	95,00 €	2,60	1	30
Ledli Kovanlı Lamba - RGB 2 Kablo /	ATS HIA009	105,00 €	2,70	1	30
Ledli Kovanlı Lamba - RGB 4 Kablo /	ATS HIA010	95,00 €	2,70	1	30
Liner Ledli Kovanlı Lamba - Beyaz /	ATS HIA006-L	105,00 €	2,60	1	30
Liner Ledli Kovanlı Lamba - RGB 2 Kablo /	ATS HIA009-L	145,00 €	2,70	1	30

Plastik gövdeli 30W/12V kovanlı tip havuz aydınlatma armatürü. / Lighting Armature with aluminium body, 30W/12V Niche Type.

Ekonomik Sıva Üstü 30W/12V

Economic Led Light Flat Type (Plastic Body) 30W/12V



Malzeme Cinsi Description	Kod Code	Fiyat (Adet) Price (Pcs)	Kg /Adet Kg/Pcs	Koli/Adet Box/Pcs	Güç(W)
Sıva Üstü Beyaz / Eco Led Light Flat Type - White	ATS HIA012-1	55,00 €	1,55	1	30
Sıva Üstü Günışığı / Eco Led Light Flat Type - Daylight	ATS HIA013-1	55,00 €	1,55	1	30
Sıva Üstü Mavi / Eco Led Light Flat Type - Blue	ATS HIA014-1	58,00 €	1,55	1	30
Sıva Üstü RGB 4 Kablo Eco Led Light Flat Type - RGB With 4 Cables	ATS HIA015-1	65,00 €	1,55	1	30
Sıva Üstü RGB 2 Kablo Eco Led Light Flat Type - RGB with 2 Cables	ATS HIA051-1	85,00 €	1,55	1	30

Alüminyum Gövde Su Soğutmalı 30 W/12V Sıva Üstü Lamba (Ledli)

Led Light Flat Type 30W/12V



Malzeme Cinsi Description	Kod Code	Fiyat (Adet) Price (Pcs)	Kg /Adet Kg/Pcs	Koli/Adet Box/Pcs	Güç(W)
Ledli Sıva Üstü Lamba - Beyaz / Led Light Flat Type - White	ATS HIA012	120,00 €	1,15	1	30
Ledli Sıva Üstü Lamba - Günışığı / Eco Led Light Flat Type - Daylight	ATS HIA013	120,00 €	1,15	1	30
Ledli Sıva Üstü Lamba - Mavi / Eco Led Light Flat Type - Blue	ATS HIA014	125,00 €	1,15	1	30
Ledli Sıva Üstü Lamba - RGB 4 Kablo Led Light Flat Type - RGB With 4 Cables	ATS HIA015	145,00 €	1,15	1	30
Ledli Sıva Üstü Lamba - RGB 2 Kablo Led Light Flat Type - RGB With 2 Cables	ATS HIA051	155,00 €	1,15	1	30

Kovanlı Lamba 300W/12V

Lamp With Sleeve 30W/12V



Malzeme Cinsi Description	Kod Code	Fiyat (Adet) Price (Pcs)	Kg /Adet Kg/Pcs	Koli/Adet Box/Pcs	Güç(W)
Kovanlı Lamba	ATS HIA001	35,00 €	2,55	1	300
Kovansız Lamba	ATS HIA002	29,00 €	2,00	1	300
Lamba Kovanı	ATS HIA003	8,00 €	0,55	1	-
Lamba Parça (Kovansız Kablosuz ve Ampülsüz)	ATS HIA004	15,00 €	1,00	1	-
Lamba Parça (Kablosuz ve Ampülsüz)	ATS HIA052	22,00 €	1,50	1	-
Kovanlı Lamba (Liner)	ATS HIA005	75,00 €	2,60	1	300

Havuz İçi Aydınlatma Lambaları İçin Paslanmaz Çerçeve 304 AISI

Stainless Steel Frame (AISI 304)



Malzeme Cinsi Description	Kod Code	Fiyat (Adet) Price (Pcs)
Sıva Üstü Paslanmaz Çerçeve /Stainless Steel Frame for Flat Type	ATS HIA053	50,00 €
Standart Model Paslanmaz Çerçeve / Stainless Steel Frame for Niche Type	ATS HIA054	65,00 €

Ekonomik Model Led Ampuller 12-18-25W/12V Par 56

Economic Led Bulb 12-18-25W/12V



Malzeme Cinsi Description	Kod Code	Fiyat (Adet) Price (Pcs)	Kg /Adet Kg/Pcs	Koli/Adet Box/Pcs	Güç(W)
Beyaz Led Eco Led Bulb - White	ATS HIA021-1	40,00 €	0,55	1	25
Gün ışığı Led Eco Led Bulb - Daylight	ATS HIA022-1	40,00 €	0,55	1	25
Mavi Led Eco Led Bulb - Blue	ATS HIA023-1	40,00 €	0,55	1	12
RGB 2 Kablo / Led Eco Led Bulb - RGB with 2 Cables	ATS HIA024-1	70,00 €	0,55	1	18
RGB 4 Kablo / Led Eco Led Bulb - RGB with 4 Cables	ATS HIA025-1	60,00 €	0,55	1	18

Model Su Soğutmalı Led Ampuller 30W/12V Par 56

Led Bulb (Aluminium Body) 30W / 12V



Malzeme Cinsi Description	Kod Code	Fiyat (Adet) Price (Pcs)	Kg /Adet Kg/Pcs	Koli/Adet Box/Pcs	Güç(W)
Beyaz Led Ampul-84 Ledli Led Bulb - White - 84 Leds	ATS HIA021	70,00 €	0,55	1	25
Günışığı Led Ampul-84 Ledli Led Bulb - Daylight - 84 Leds	ATS HIA022	70,00 €	0,55	1	25
Mavi Led Ampul-270 Ledli Led Bulb - Blue - 270 Led	ATS HIA023	80,00 €	0,55	1	12
RGB 2 Kablo / Led Ampul - 150 Ledli Led Bulb - RGB with 2 Cables - 150 Leds	ATS HIA024	115,00 €	0,55	1	18
RGB 4 Kablo / Led Ampul - 150 Ledli Led Bulb - RGB with 2 Cables - 150 Leds	ATS HIA025	100,00 €	0,55	1	18

Not: Ampüller alüminyum gövdelidir.
Note: Bulbs are covered with plastic body.**Yedek Ampuller 100-300W/12V**

Malzeme Cinsi Description	Kod Code	Fiyat (Adet) Price (Pcs)	Kg /Adet Kg/Pcs	Koli/Adet Box/Pcs	Güç(W)
Par 56 Ampül Ekonomik	ATS HIA019	16,00 €	0,55	1	300
Halojen Ampül	ATS HIA020	9,00 €	0,55	1	100

Trafolar (12V)

Transformers (12V)



Malzeme Cinsi Description	Kod Code	Fiyat (Adet) Price (Pcs)	Kg /Adet Kg/Pcs	Koli/Adet Box/Pcs	Güç(W)
Trafo / Transformers	ATS HIA026	25,00 €	3,40	1	50
Trafo / Transformers	ATS HIA027	28,00 €	3,45	1	100
Trafo / Transformers	ATS HIA028	33,00 €	4,45	1	300
Trafo / Transformers	ATS HIA029	49,00 €	5,65	1	400
Trafo / Transformers	ATS HIA030	88,00 €	9,30	1	600

Lamba Beton Kalıbı

Light Niche Box



Malzeme Cinsi Description	Kod Code	Fiyat (Adet) Price (Pcs)	Kg /Adet Kg/Pcs	Koli/Adet Box/Pcs
Lamba Beton Kalıbı Light Niche Concrete Box	ATS HIA052	5,50 €	0,55	1

Kablo ve Kablo Kılıfı

Underwater Cable And Cable Sleeve



Malzeme Cinsi Description	Kod Code	Fiyat (Adet) Price (Pcs)	Kg /Adet Kg/Pcs	Koli/Adet Box/Pcs
2 x 4 TTR Kablo / Cable	ATS HIA031	2,50 €	19,00	1
2 x 6 TTR Kablo / Cable	ATS HIA032	3,10 €	20,00	1
2 x 2,5 TTR Kablo / Cable	ATS HIA050	2,50 €	18,00	1
4 x 2,5 TTR Kablo / Cable	ATS HIA033	2,50 €	19,00	1
Lamba Kablo Kılıfı / Light Cable Sleeve	ATS HIA034	1,50 €	4,70	1

Not : Paket ölçüsü ve ağırlığı 100 mt için verilmiştir.
Note: Package size and weight are given for 100 mt.

RGB Kumanda Ünitesi
 RGB Control Units

Malzeme Cinsi Description	Kod Code	Fiyat (Adet) Price (Pcs)	Kg /Adet Kg/Pcs	Koli/Adet Box/Pcs
RGB Uzaktan Kumanda ve Alıcı Modülör 4 Kablolü RGB Synchronization Box with Remote Control and Receiver Modulator - With 4 Cables - Max. 8 Lamps	ATS HIA036	95,00 €	-	1
RGB Uzaktan Kumanda ve Alıcı Modülör 2 Kablolü RGB Synchronization Box with Remote Control and Receiver Modulator - With 2 Cables - Max. 12 Lamps	ATS HIA152	120,00 €	-	1
Modulator RGB Kontrol Panosu 2-4 Damarlı Kablo Modulator RGB Control Panel (For 2-4 Cores Cable) For 20 armatures Additional modulator (Additional modulator)	ATS HIA035	370,00 €	-	1
RGB Kontrol Panosu İlavesi 2-4 Damarlı Kablo Extra RGB Control Panel (For 2-4 Cores Cable) For 40 armatures (Additional modulator)	ATS HIA037	300,00 €	-	1

RF Kumandalıdır. Açık alanda 50mt mesafeden kumanda edebilir.

RGB Synchronization Box with Remote Control and Receiver Modulator (Max for 8 armatures) With 2 Cables.
Remote Control without Control Panel.

Villa Tipi Pano
 Villa Type Control Panels

Malzeme Cinsi Description	Kod Code	Fiyat (Adet) Price (Pcs)	Kg /Adet Kg/Pcs	Koli/Adet Box/Pcs
Monofaze Villa Tipi Pano (1 pompa + 5 lamba) Monophase Villa Type Control Panel (1 Pump+5 Armatures)	ATS HIA038	80,00 €	1,40	1
Trifaze Villa Tipi Pano (1 pompa + 6 lamba) Threephase Villa Type Control Panel (1 Pump+6 Armatures)	ATS HIA039	150,00 €	2,60	1

3 HP pompaya kadardır. / Up to 3 HP Pump

Siemens Malzemeli Elektrik Kumanda Panoları
 Control Panels With Siemens Equipment

Malzeme Cinsi Description	Kod Code	Fiyat (Adet) Price (Pcs)	Kg /Adet Kg/Pcs	Koli/Adet Box/Pcs
1 Pompa - 1 Grup Lambalı pano (6 Lamba) 1 Pump - 1 Group With Armature (6 Armatures)	ATS HIA040	450,00 €	5,80	1
2 Pompa - 2 Grup Lambalı pano (12 Lamba) 2 Pump - 2 Group With Armature (12 Armatures)	ATS HIA041	600,00 €	7,40	1
3 Pompa - 3 Grup Lambalı pano (18 Lamba) 3 Pump - 3 Group With Armature (18 Armatures)	ATS HIA042	950,00 €	-	1
4 Pompa - 4 Grup Lambalı pano (24 Lamba) 4 Pump - 4 Group With Armature (24 Armatures)	ATS HIA043	1.200,00 €	-	1
5 Pompa - 5 Grup Lambalı pano (30 Lamba) 5 Pump - 5 Group With Armature (30 Armatures)	ATS HIA044	1.400,00 €	-	1

İçinde W Otomat, kontaktör, termik ve 1 adet faz koruma rölesi bulunmaktadır.Çıkışlar ray klemensler vasıtasıyla yapılmaktadır. Kumandalar Pako şaltellerden sağlanır.Pompa ve lambaların ARIZA ve ÇALIŞIYOR sinyal lambaları mevcuttur. Kaçak akım korumalıdır.

Included W Automat, Contactor,Thermic and 1 phase protection relay. The outputs are made via rail terminals. Controls are provided by Pako switches. Pumps and lights have FAULT and WORK Signal lamps. The Leakage Current Protection.

Ekonomik Kumanda Panoları
 Economic Control Panels

Malzeme Cinsi Description	Kod Code	Fiyat (Adet) Price (Pcs)	Kg /Adet Kg/Pcs	Koli/Adet Box/Pcs
1 Pompa - 1 Grup Lambalı pano (6 Lamba) 1 Pump - 1 Group With Armature (6 Armatures)	ATS HIA045	325,00 €	-	1
2 Pompa - 2 Grup Lambalı pano (12 Lamba) 2 Pump - 2 Group With Armature (12 Armatures)	ATS HIA046	505,00 €	-	1
3 Pompa - 3 Grup Lambalı pano (18 Lamba) 3 Pump - 3 Group With Armature (18 Armatures)	ATS HIA047	690,00 €	-	1
4 Pompa - 4 Grup Lambalı pano (24 Lamba) 4 Pump - 4 Group With Armature (24 Armatures)	ATS HIA048	925,00 €	-	1
5 Pompa - 5 Grup Lambalı pano (30 Lamba) 5 Pump - 5 Group With Armature (30 Armatures)	ATS HIA049	1.050,00 €	-	1

İçinde W Otomat, kontaktör, termik ve 1 adet faz koruma rölesi bulunmaktadır.Çıkışlar ray klemensler vasıtasıyla yapılmaktadır. Kumandalar Pako şaltellerden sağlanır.Pompa ve lambaların ARIZA ve ÇALIŞIYOR sinyal lambaları mevcuttur. Kaçak akım korumalıdır.

Included W Automat, Contactor,Thermic and 1 phase protection relay. The outputs are made via rail terminals. Controls are provided by Pako switches. Pumps and lights have FAULT and WORK Signal lamps. The Leakage Current Protection.

HAVUZ İÇİ VE KENAR EKİPMANLARI POOL BASIN AND SIDE EQUIPMENTS

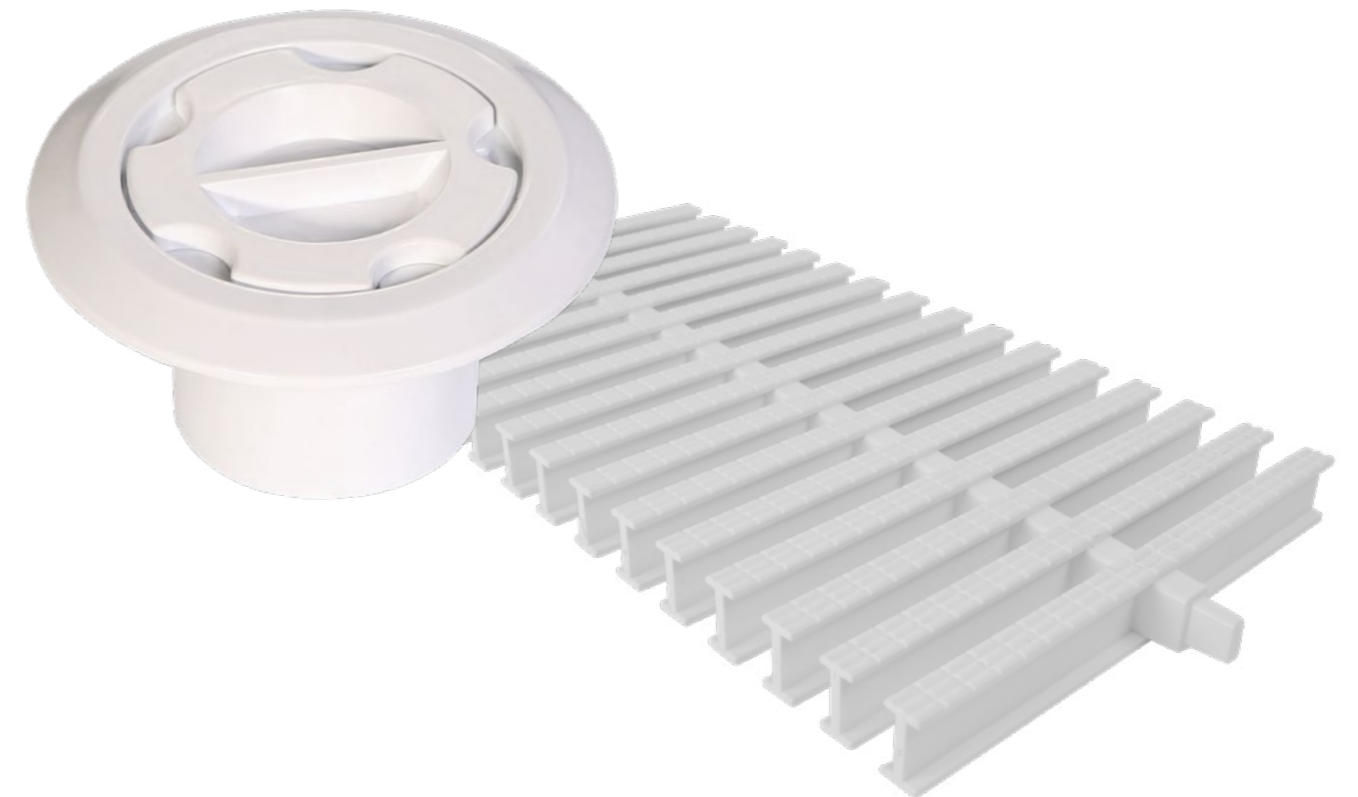

STANDART SERİ MERDİVEN (AISI 304)
 STANDARD SERIE LADDER (AISI 304)

Standart Paslanmaz Çelik Kaymaz Basamaklı Merdiven
 Anchor Type Stainless Steel Step with Anti-Slip Pad

Malzeme Cinsi Description	Kod Code	Fiyat (Adet) Price (Pcs)	Kg /Adet Kg/Pcs	Koli/Adet Box/Pcs
2 Basamaklı Standart Merdiven Standard Ladder with 2 Treads	ATS HKE001	160,00 €	10,00	1
3 Basamaklı Standart Merdiven Standard Ladder with 2 Treads	ATS HKE002	170,00 €	11,50	1
4 Basamaklı Standart Merdiven Standard Ladder with 2 Treads	ATS HKE003	190,00 €	13,50	1
5 Basamaklı Standart Merdiven Standard Ladder with 2 Treads	ATS HKE004	230,00 €	15,00	1

Paslanmaz çelik Ø43 mm borudan mamül paslanmaz çelik kaymaz basamaklı; genişlik 51cm rozetleri ve montaj parçaları ile birlikte.

Made of stainless steel Ø43 mm pipe and anti-slip treads; separation between handrails 51 cm. Supplied with all necessary fittings for attachment. With plastic anchoring and stainless steel trims.

Standart Paslanmaz Çelik Merdiven
 Anchor Type Stainless Steel Step

Malzeme Cinsi Description	Kod Code	Fiyat (Adet) Price (Pcs)	Kg /Adet Kg/Pcs	Koli/Adet Box/Pcs
2 Basamaklı Standart Merdiven Standard Ladder with 2 Treads	ATS HKE001-S	150,00 €	10,00	1
3 Basamaklı Standart Merdiven Standard Ladder with 2 Treads	ATS HKE002-S	160,00 €	11,50	1
4 Basamaklı Standart Merdiven Standard Ladder with 2 Treads	ATS HKE003-S	180,00 €	13,50	1
5 Basamaklı Standart Merdiven Standard Ladder with 2 Treads	ATS HKE004-S	220,00 €	15,00	1

Paslanmaz çelik Ø43 mm borudan mamül paslanmaz çelik; genişlik 51cm rozetleri ve montaj parçaları ile birlikte.

Made of stainless steel Ø43 mm pipe. Separation between handrails 51 cm. Supplied with all necessary fittings for attachment. With plastic anchoring and stainless steel trims.

Standart Paslanmaz Çelik Plastik Basamaklı Merdiven
 Anchor Type Plastic Step

Malzeme Cinsi Description	Kod Code	Fiyat (Adet) Price (Pcs)	Kg /Adet Kg/Pcs	Koli/Adet Box/Pcs
2 Basamaklı Standart Merdiven Standard Ladder with 2 Treads	ATS HKE001-P	140,00 €	10,00	1
3 Basamaklı Standart Merdiven Standard Ladder with 2 Treads	ATS HKE002-P	150,00 €	11,50	1
4 Basamaklı Standart Merdiven Standard Ladder with 2 Treads	ATS HKE003-P	170,00 €	13,50	1
5 Basamaklı Standart Merdiven Standard Ladder with 2 Treads	ATS HKE004-P	220,00 €	15,00	1

Paslanmaz çelik Ø43 mm borudan mamül paslanmaz çelik plastik basamaklı; genişlik 51cm rozetleri ve montaj parçaları ile birlikte.

Made of stainless steel Ø43 mm pipe and plastic treads; separation between handrails 51 cm. Supplied with all necessary fittings for attachment. With plastic anchoring and stainless steel trims.

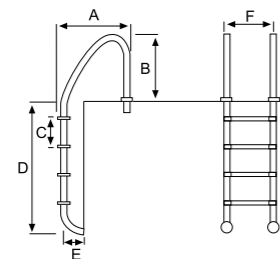

Basamak	A	B	C	D	E	F
2	600	620	250	680	170	500
3	600	620	250	930	170	500
4	600	620	250	1180	170	500
5	600	620	250	1430	170	500

MURO SERİ MERDİVEN (AISI 304)
 MURO SERIE LADDER (AISI 304)

Muro Paslanmaz Çelik Kaymaz Basamaklı Merdiven
 Anchor Type Stainless Steel Step with Anti-Slip Pad

Malzeme Cinsi Description	Kod Code	Fiyat (Adet) Price (Pcs)	Kg /Adet Kg/Pcs	Koli/Adet Box/Pcs
2 Basamaklı Muro Merdiven Muro Ladder with 2 Treads	ATS HKE005	160,00 €	9,50	1
3 Basamaklı Muro Merdiven Muro Ladder with 3 Treads	ATS HKE006	170,00 €	10,50	1
4 Basamaklı Muro Merdiven Muro Ladder with 4 Treads	ATS HKE007	190,00 €	12,50	1
5 Basamaklı Muro Merdiven Muro Ladder with 5 Treads	ATS HKE008	230,00 €	14,00	1

Paslanmaz çelik Ø43 mm borudan mamül paslanmaz çelik kaymaz basamaklı; genişlik 51cm rozetleri ve montaj parçaları ile birlikte.

Made of stainless steel Ø43 mm pipe and anti-slip treads; separation between handrails 51 cm. Supplied with all necessary fittings for attachment. With plastic anchoring and stainless steel trims.

Muro Paslanmaz Çelik Merdiven
 Anchor Type Stainless Steel Step

Malzeme Cinsi Description	Kod Code	Fiyat (Adet) Price (Pcs)	Kg /Adet Kg/Pcs	Koli/Adet Box/Pcs
2 Basamaklı Muro Merdiven Muro Ladder with 2 Treads	ATS HKE005-S	150,00 €	9,50	1
3 Basamaklı Muro Merdiven Muro Ladder with 3 Treads	ATS HKE006-S	160,00 €	10,50	1
4 Basamaklı Muro Merdiven Muro Ladder with 4 Treads	ATS HKE007-S	180,00 €	12,50	1
5 Basamaklı Muro Merdiven Muro Ladder with 5 Treads	ATS HKE008-S	220,00 €	14,00	1

Paslanmaz çelik Ø43 mm borudan mamül paslanmaz çelik; genişlik 51cm rozetleri ve montaj parçaları ile birlikte.

Made of stainless steel Ø43 mm pipe. Separation between handrails 51 cm. Supplied with all necessary fittings for attachment. With plastic anchoring and stainless steel trims.

Muro Paslanmaz Çelik Plastik Basamaklı Merdiven
 Anchor Type Plastic Step

Malzeme Cinsi Description	Kod Code	Fiyat (Adet) Price (Pcs)	Kg /Adet Kg/Pcs	Koli/Adet Box/Pcs
2 Basamaklı Muro Merdiven Muro Ladder with 2 Treads	ATS HKE005-P	140,00 €	9,50	1
3 Basamaklı Muro Merdiven Muro Ladder with 3 Treads	ATS HKE006-P	150,00 €	10,50	1
4 Basamaklı Muro Merdiven Muro Ladder with 4 Treads	ATS HKE007-P	170,00 €	12,50	1
5 Basamaklı Muro Merdiven Muro Ladder with 5 Treads	ATS HKE008-P	220,00 €	14,00	1

Paslanmaz çelik Ø43 mm borudan mamül paslanmaz çelik plastik basamaklı; genişlik 51cm rozetleri ve montaj parçaları ile birlikte.

Made of stainless steel Ø43 mm pipe and plastic treads; separation between handrails 51 cm. Supplied with all necessary fittings for attachment. With plastic anchoring and stainless steel trims.

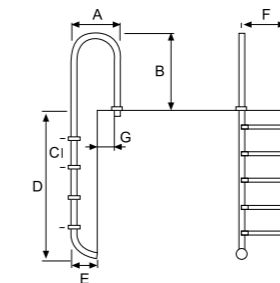

Basamak	A	B	C	D	E	F	G
2	350	620	250	710	170	500	200
3	350	620	250	960	170	500	200
4	350	620	250	1120	170	500	200
5	350	620	250	1460	170	500	200

MİXTA SERİ MERDİVEN (AISI 304)
 MIXTA SERIE LADDER (AISI 304)

Mixta Paslanmaz Çelik Kaymaz Basamaklı Merdiven
 Anchor Type Stainless Steel Step with Anti-Slip Pad

Malzeme Cinsi Description	Kod Code	Fiyat (Adet) Price (Pcs)	Kg /Adet Kg/Pcs	Koli/Adet Box/Pcs
2 Basamaklı Mixta Merdiven Mixta Ladder with 2 Treads	ATS HKE009	165,00 €	10,00	1
3 Basamaklı Mixta Merdiven Mixta Ladder with 3 Treads	ATS HKE010	180,00 €	11,50	1
4 Basamaklı Mixta Merdiven Mixta Ladder with 4 Treads	ATS HKE011	200,00 €	13,50	1
5 Basamaklı Mixta Merdiven Mixta Ladder with 5 Treads	ATS HKE012	250,00 €	15,00	1

Paslanmaz çelik Ø43 mm borudan mamül paslanmaz çelik kaymaz basamaklı; genişlik 51cm rozetleri ve montaj parçaları ile birlikte.
 Made of stainless steel Ø43 mm pipe and anti-slip treads; seperation between handrails 51 cm. Supplied with all necessary fittings for attachment. With plastic anchoring and stainless steel trims.

Mixta Paslanmaz Çelik Merdiven
 Anchor Type Stainless Steel Step

Malzeme Cinsi Description	Kod Code	Fiyat (Adet) Price (Pcs)	Kg /Adet Kg/Pcs	Koli/Adet Box/Pcs
2 Basamaklı Mixta Merdiven Mixta Ladder with 2 Treads	ATS HKE009-S	155,00 €	10,00	1
3 Basamaklı Mixta Merdiven Mixta Ladder with 3 Treads	ATS HKE010-S	170,00 €	11,50	1
4 Basamaklı Mixta Merdiven Mixta Ladder with 4 Treads	ATS HKE011-S	190,00 €	13,50	1
5 Basamaklı Mixta Merdiven Mixta Ladder with 5 Treads	ATS HKE012-S	240,00 €	15,00	1

Paslanmaz çelik Ø43 mm borudan mamül paslanmaz çelik; genişlik 51cm rozetleri ve montaj parçaları ile birlikte.
 Made of stainless steel Ø43 mm pipe. Seperation between handrails 51 cm. Supplied with all necessary fittings for attachment. With plastic anchoring and stainless steel trims.

Mixta Paslanmaz Çelik Plastik Basamaklı Merdiven
 Anchor Type Plastic Step

Malzeme Cinsi Description	Kod Code	Fiyat (Adet) Price (Pcs)	Kg /Adet Kg/Pcs	Koli/Adet Box/Pcs
2 Basamaklı Mixta Merdiven Mixta Ladder with 2 Treads	ATS HKE009-P	145,00 €	10,00	1
3 Basamaklı Mixta Merdiven Mixta Ladder with 3 Treads	ATS HKE010-P	160,00 €	11,50	1
4 Basamaklı Mixta Merdiven Mixta Ladder with 4 Treads	ATS HKE011-P	180,00 €	13,50	1
5 Basamaklı Mixta Merdiven Mixta Ladder with 5 Treads	ATS HKE012-P	220,00 €	15,00	1

Paslanmaz çelik Ø43 mm borudan mamül paslanmaz çelik plastik basamaklı; genişlik 51cm rozetleri ve montaj parçaları ile birlikte.
 Made of stainless steel Ø43 mm pipe and plastic treads; seperation between handrails 51 cm. Supplied with all necessary fittings for attachment. With plastic anchoring and stainless steel trims.

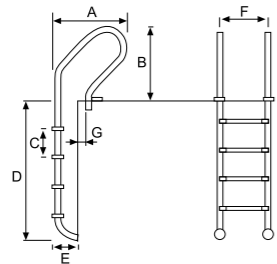

Basamak	A	B	C	D	E	F	G
2	600	620	250	680	170	500	280
3	600	620	250	930	170	500	280
4	600	620	250	1180	170	500	280
5	600	620	250	1430	170	500	280

AÇIK TIP FLANŞ BAĞLANTILI MERDİVEN (AISI 304)
 OPEN TYPE LADDER WITH FLANGE CONNECTION (AISI 304)

Açık Tip Flanş Bağlantılı Paslanmaz Çelik Kaymaz Basamaklı Merdiven
 Flange Type Stainless Steel Step with Anti-Slip Pad

Malzeme Cinsi Description	Kod Code	Fiyat (Adet) Price (Pcs)	Kg /Adet Kg/Pcs	Koli/Adet Box/Pcs
2 Basamaklı Merdiven Açık Tip Open Ladder with 2 Treads	ATS HKE013	250,00 €	12,50	1
3 Basamaklı Merdiven Açık Tip Open Ladder with 3 Treads	ATS HKE014	270,00 €	13,00	1
4 Basamaklı Merdiven Açık Tip Open Ladder with 4 Treads	ATS HKE015	310,00 €	15,00	1
5 Basamaklı Merdiven Açık Tip Open Ladder with 5 Treads	ATS HKE016	330,00 €	17,50	1

Paslanmaz çelik Ø43 mm borudan mamül paslanmaz çelik kaymaz basamaklı; genişlik 51cm rozetleri ve montaj parçaları ile birlikte.
 Made of stainless steel Ø43 mm pipe and anti-slip treads; seperation between handrails 51 cm. Supplied with all necessary fittings for attachment. With plastic anchoring and stainless steel trims.

Açık Tip Flanş Bağlantılı Paslanmaz Çelik Merdiven
 Flange Type Stainless Steel Step

Malzeme Cinsi Description	Kod Code	Fiyat (Adet) Price (Pcs)	Kg /Adet Kg/Pcs	Koli/Adet Box/Pcs
2 Basamaklı Merdiven Açık Tip Open Ladder with 2 Treads	ATS HKE013-S	240,00 €	12,50	1
3 Basamaklı Merdiven Açık Tip Open Ladder with 3 Treads	ATS HKE014-S	260,00 €	13,00	1
4 Basamaklı Merdiven Açık Tip Open Ladder with 4 Treads	ATS HKE015-S	300,00 €	15,00	1
5 Basamaklı Merdiven Açık Tip Open Ladder with 5 Treads	ATS HKE016-S	320,00 €	17,50	1

Paslanmaz çelik Ø43 mm borudan mamül paslanmaz çelik; genişlik 51cm rozetleri ve montaj parçaları ile birlikte.
 Made of stainless steel Ø43 mm pipe. Seperation between handrails 51 cm. Supplied with all necessary fittings for attachment. With plastic anchoring and stainless steel trims.

Açık Tip Flanş Bağlantılı Paslanmaz Çelik Plastik Basamaklı Merdiven
 Flange Type Plastic Step

Malzeme Cinsi Description	Kod Code	Fiyat (Adet) Price (Pcs)	Kg /Adet Kg/Pcs	Koli/Adet Box/Pcs
2 Basamaklı Merdiven Açık Tip Open Ladder with 2 Treads	ATS HKE013-P	230,00 €	12,50	1
3 Basamaklı Merdiven Açık Tip Open Ladder with 3 Treads	ATS HKE014-P	250,00 €	13,00	1
4 Basamaklı Merdiven Açık Tip Open Ladder with 4 Treads	ATS HKE015-P	290,00 €	15,00	1
5 Basamaklı Merdiven Açık Tip Open Ladder with 5 Treads	ATS HKE016-P	310,00 €	17,50	1

Paslanmaz çelik Ø43 mm borudan mamül paslanmaz çelik plastik basamaklı; genişlik 51cm rozetleri ve montaj parçaları ile birlikte.
 Made of stainless steel Ø43 mm pipe and plastic treads; seperation between handrails 51 cm. Supplied with all necessary fittings for attachment. With plastic anchoring and stainless steel trims.

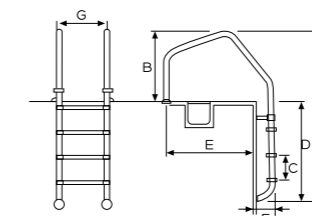

Basamak	A	B	C	D	E	F	G
2	1390	680	250	710	842	180	500
3	1640	680	250	960	842	180	500
4	1890	680	250	1210	842	180	500
5	2140	680	250	1460	842	180	500

STANDART SERİ MERDİVEN (AISI 316)
 STANDARD SERIE LADDER (AISI 316)

Standart Paslanmaz Çelik Kaymaz Basamaklı Merdiven
 Anchor Type Stainless Steel Step with Anti-Slip Pad

Malzeme Cinsi Description	Kod Code	Fiyat (Adet) Price (Pcs)	Kg /Adet Kg/Pcs	Koli/Adet Box/Pcs
2 Basamaklı Standart Merdiven Standard Ladder with 2 Treads	ATS HKE017	330,00 €	10,00	1
3 Basamaklı Standart Merdiven Standard Ladder with 2 Treads	ATS HKE018	385,00 €	11,50	1
4 Basamaklı Standart Merdiven Standard Ladder with 2 Treads	ATS HKE019	435,00 €	13,50	1
5 Basamaklı Standart Merdiven Standard Ladder with 2 Treads	ATS HKE020	490,00 €	15,00	1

Paslanmaz çelik Ø43 mm borudan mamül paslanmaz çelik kaymaz basamaklı; genişlik 51cm rozetleri ve montaj parçaları ile birlikte.

Made of stainless steel Ø43 mm pipe and anti-slip treads; seperation between handrails 51 cm. Supplied with all necessary fittings for attachment. With plastic anchoring and stainless steel trims.

Standart Paslanmaz Çelik Merdiven
 Anchor Type Stainless Steel Step

Malzeme Cinsi Description	Kod Code	Fiyat (Adet) Price (Pcs)	Kg /Adet Kg/Pcs	Koli/Adet Box/Pcs
2 Basamaklı Standart Merdiven Standard Ladder with 2 Treads	ATS HKE017-S	320,00 €	10,00	1
3 Basamaklı Standart Merdiven Standard Ladder with 2 Treads	ATS HKE018-S	375,00 €	11,50	1
4 Basamaklı Standart Merdiven Standard Ladder with 2 Treads	ATS HKE019-S	425,00 €	13,50	1
5 Basamaklı Standart Merdiven Standard Ladder with 2 Treads	ATS HKE020-S	475,00 €	15,00	1

Paslanmaz çelik Ø43 mm borudan mamül paslanmaz çelik; genişlik 51cm rozetleri ve montaj parçaları ile birlikte.

Made of stainless steel Ø43 mm pipe. Seperation between handrails 51 cm. Supplied with all necessary fittings for attachment. With plastic anchoring and stainless steel trims.

Standart Paslanmaz Çelik Plastik Basamaklı Merdiven
 Anchor Type Plastic Step

Malzeme Cinsi Description	Kod Code	Fiyat (Adet) Price (Pcs)	Kg /Adet Kg/Pcs	Koli/Adet Box/Pcs
2 Basamaklı Standart Merdiven Standard Ladder with 2 Treads	ATS HKE017-P	310,00 €	10,00	1
3 Basamaklı Standart Merdiven Standard Ladder with 2 Treads	ATS HKE018-P	354,00 €	11,50	1
4 Basamaklı Standart Merdiven Standard Ladder with 2 Treads	ATS HKE019-P	415,00 €	13,50	1
5 Basamaklı Standart Merdiven Standard Ladder with 2 Treads	ATS HKE020-P	465,00 €	15,00	1

Paslanmaz çelik Ø43 mm borudan mamül paslanmaz çelik plastik basamaklı; genişlik 51cm rozetleri ve montaj parçaları ile birlikte.

Made of stainless steel Ø43 mm pipe and plastic treads; seperation between handrails 51 cm. Supplied with all necessary fittings for attachment. With plastic anchoring and stainless steel trims.

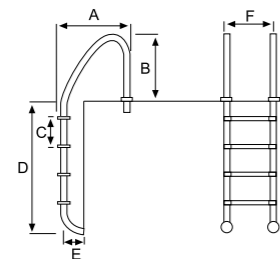

Basamak	A	B	C	D	E	F
2	600	620	250	680	170	500
3	600	620	250	930	170	500
4	600	620	250	1180	170	500
5	600	620	250	1430	170	500

MURO SERİ MERDİVEN (AISI 316)
 MURO SERIE LADDER (AISI 316)

Muro Paslanmaz Çelik Kaymaz Basamaklı Merdiven
 Anchor Type Stainless Steel Step with Anti-Slip Pad

Malzeme Cinsi Description	Kod Code	Fiyat (Adet) Price (Pcs)	Kg /Adet Kg/Pcs	Koli/Adet Box/Pcs
2 Basamaklı Muro Merdiven Muro Ladder with 2 Treads	ATS HKE021	330,00 €	9,50	1
3 Basamaklı Muro Merdiven Muro Ladder with 3 Treads	ATS HKE022	385,00 €	10,50	1
4 Basamaklı Muro Merdiven Muro Ladder with 4 Treads	ATS HKE023	435,00 €	12,50	1
5 Basamaklı Muro Merdiven Muro Ladder with 5 Treads	ATS HKE024	490,00 €	14,00	1

Paslanmaz çelik Ø43 mm borudan mamül paslanmaz çelik kaymaz basamaklı; genişlik 51cm rozetleri ve montaj parçaları ile birlikte.

Made of stainless steel Ø43 mm pipe and anti-slip treads; seperation between handrails 51 cm. Supplied with all necessary fittings for attachment. With plastic anchoring and stainless steel trims.

Muro Paslanmaz Çelik Merdiven
 Anchor Type Stainless Steel Step

Malzeme Cinsi Description	Kod Code	Fiyat (Adet) Price (Pcs)	Kg /Adet Kg/Pcs	Koli/Adet Box/Pcs
2 Basamaklı Muro Merdiven Muro Ladder with 2 Treads	ATS HKE021-S	320,00 €	9,50	1
3 Basamaklı Muro Merdiven Muro Ladder with 3 Treads	ATS HKE022-S	375,00 €	10,50	1
4 Basamaklı Muro Merdiven Muro Ladder with 4 Treads	ATS HKE023-S	425,00 €	12,50	1
5 Basamaklı Muro Merdiven Muro Ladder with 5 Treads	ATS HKE024-S	475,00 €	14,00	1

Paslanmaz çelik Ø43 mm borudan mamül paslanmaz çelik; genişlik 51cm rozetleri ve montaj parçaları ile birlikte.

Made of stainless steel Ø43 mm pipe. Seperation between handrails 51 cm. Supplied with all necessary fittings for attachment. With plastic anchoring and stainless steel trims.

Muro Paslanmaz Çelik Plastik Basamaklı Merdiven
 Anchor Type Plastic Step

Malzeme Cinsi Description	Kod Code	Fiyat (Adet) Price (Pcs)	Kg /Adet Kg/Pcs	Koli/Adet Box/Pcs
2 Basamaklı Muro Merdiven Muro Ladder with 2 Treads	ATS HKE021-P	310,00 €	9,50	1
3 Basamaklı Muro Merdiven Muro Ladder with 3 Treads	ATS HKE022-P	354,00 €	10,50	1
4 Basamaklı Muro Merdiven Muro Ladder with 4 Treads	ATS HKE023-P	415,00 €	12,50	1
5 Basamaklı Muro Merdiven Muro Ladder with 5 Treads	ATS HKE024-P	465,00 €	14,00	1

Paslanmaz çelik Ø43 mm borudan mamül paslanmaz çelik plastik basamaklı; genişlik 51cm rozetleri ve montaj parçaları ile birlikte.

Made of stainless steel Ø43 mm pipe and plastic treads; seperation between handrails 51 cm. Supplied with all necessary fittings for attachment. With plastic anchoring and stainless steel trims.

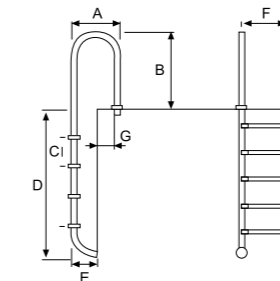

Basamak	A	B	C	D	E	F	G
2	350	620	250	710	170	500	200
3	350	620	250	960	170	500	200
4	350	620	250	1120	170	500	200
5	350	620	250	1460	170	500	200

Merdiven Yedek Parçaları (AISI 316)
 Ladder Spare Parts (AISI 316)

Malzeme Cinsi Description	Kod Code	Fiyat (Adet) Price (Pcs)	Kg /Adet Kg/Pcs	Koli/Adet Box/Pcs
Merdiven Basamağı - Paslanmaz Çelik Ladder Step - Stainless Steel	ATS HKE025	40,00 €	-	1
Merdiven Basamağı - Plastik Ladder Step - Plastic	ATS HKE026	19,00 €	-	1
Merdiven Lastik Takozu Ladder Rubber Bumper	ATS HKE027	6,00 €	-	1
Merdiven Ankracı Ladder Anchor	ATS HKE028	11,00 €	-	1
Merdiven Rozeti (Aynası 105 mm) Ladder Escutcheon (Mirror 105 mm)	ATS HKE029	11,00 €	-	1

Duşlar (AISI 304)
 Showers (AISI 304)

Malzeme Cinsi Description	Kod Code	Fiyat (Adet) Price (Pcs)	Kg /Adet Kg/Pcs	Koli/Adet Box/Pcs
Standart Tekli Duş 43mm ½ Bağlantılı Standard Single Shower 43 mm ½ Connection	ATS HKE030	370,00 €	5,00	1
Standart İkili Duş 43mm ½ Bağlantılı Standard Double Shower 43 ½ Connection	ATS HKE031	1.150,00 €	8,00	1
Ayak Musluklu Duş 43mm ½ Bağlantılı Shower with Foot-Bath 43 mm ½ Connection	ATS HKE032	421,00 €	8,00	1
4lü Otomatik Duş 120x120 mm ¾" Bağlantılı Quartet Automatic Shower 120x120 mm ¾ Connection	ATS HKE033	3.320,00 €	20,00	1
Solar Duş - 25 lt. kapasiteli ½" Bağlantılı Solar Shower - 25lt. Capacity ½ Connection	ATS HKE034	1.110,00 €	14,70	1
Solar Duş - 30 lt. kapasiteli ½" Bağlantılı Solar Shower - 30lt. Capacity ½ Connection	ATS HKE035	1.175,00 €	40,00	1

Paslanmaz Çelik Havuz Tutunma Kolu
 Stainless Steel Pool Handle

Malzeme Cinsi Description	Kod Code	Fiyat (Adet) Price (Pcs)	Kg /Adet Kg/Pcs	Koli/Adet Box/Pcs
0,5 mt Tutunma kolu 0,5 mt Grab Handle	ATS HKE036	120,00 €	1,20	1
1,0 mt Tutunma kolu 1,0 mt Grab Handle	ATS HKE037	155,00 €	1,70	1
1,5 mt Tutunma kolu 1,5 mt Grab Handle	ATS HKE038	190,00 €	2,30	1
2,0 mt Tutunma kolu 2,0 mt Grab Handle	ATS HKE039	220,00 €	2,80	1
2,5 mt Tutunma kolu 2,5 mt Grab Handle	ATS HKE040	270,00 €	3,30	1

AISI 304 Kalite Ø42 mm x 1,5 mm paslanmaz çelik borudan imal edilmiştir.
 Made of AISI 304 Quality Ø42 mm x 1,5 mm stainless steel pipe.

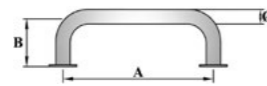

Basamak	A	B	C
ATS HKE036	50 cm	12 cm	43 cm
ATS HKE037	100 cm	12 cm	43 cm
ATS HKE038	150 cm	12 cm	43 cm
ATS HKE039	200 cm	12 cm	43 cm
ATS HKE040	250 cm	12 cm	43 cm

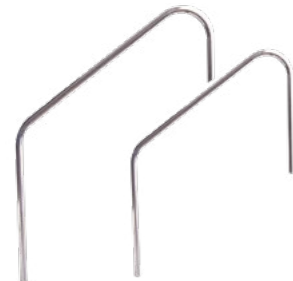
Tutamaklar
 Handles

Malzeme Cinsi Description	Kod Code	Fiyat (Adet) Price (Pcs)	Kg /Adet Kg/Pcs	Koli/Adet Box/Pcs
Büyük Tip Merdiven Tutamağı Large ladder handle	ATS HKE041	530,00 €	9,20	1
Küçük Tip Merdiven Tutamağı Small ladder handle	ATS HKE042	475,00 €	8,20	1

AISI 304 Kalite Ø42 mm x 1,5 mm paslanmaz çelik borudan imal edilmiştir.
 Made of AISI 304 Quality Ø42 mm x 1,5 mm stainless steel pipe.

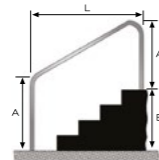

Kod	A	B	L	Ø
ATS HKE041	800 mm	855 mm	1525 mm	43 mm
ATS HKE042	800 mm	680 mm	1220 mm	43 mm



P.P. Tek Geçme Savak Izgarası (8 mm aralıklı)

P.P Single Joint Overflow Grating (8 mm)

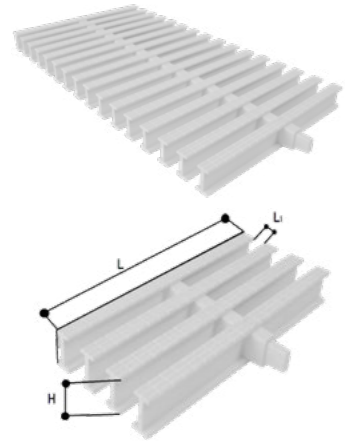

Malzeme Cinsi Description	Model	Kod Code	Fiyat (m) Price (m)	Kg /Koli Kg/Bag	L (mm)	L1 (mm)	H (mm)
15 cm	T	ATS HKE043	7,00 €	11,00	145	8	25
20 cm	I-T	ATS HKE044	8,00 €	13,00	195	8	25
20 cm	I	ATS HKE044_1	8,00 €	13,00	192	8	25
25 cm	I	ATS HKE045	9,00 €	17,00	245	8	25

P.P. Çift Geçme Savak Izgarası (8 mm aralıklı)

P.P Double Joint Overflow Grating (8 mm)

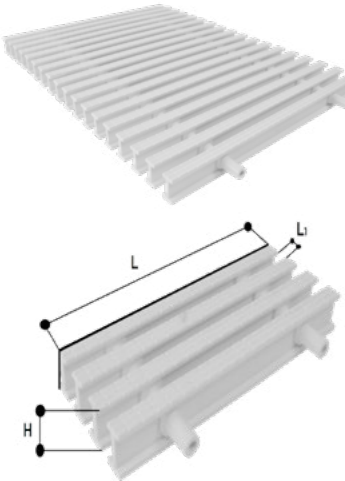

Malzeme Cinsi Description	Model	Kod Code	Fiyat (m) Price (m)	Kg /Koli Kg/Bag	Koli/Adet Box/Pcs	L (mm)	L1 (mm)	H (mm)
20 cm	T	ATS HKE046	10,00 €	17,00	1			
20 cm	I	ATS HKE047	9,00 €	17,00	1	195	8	25
20 cm	I	ATS HKE047-1	9,00 €	15,00	1	192	8	25
25 cm	I	ATS HKE048	10,00 €	20,00	1	245	8	25
30 cm	I	ATS HKE049	18,00 €	11,00	1	295	8	25

P.P. Tek / Çift Geçme Savak Izgarası (10 mm aralıklı)

P.P Single / Double Joint Overflow Grating (10 mm)

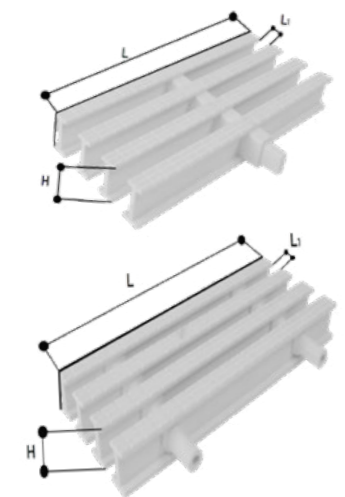

Malzeme Cinsi Description	Model	Kod Code	Fiyat (m) Price (m)	Kg /Koli Kg/Bag	Koli/Adet Box/Pcs	L (mm)	L1 (mm)	H (mm)
20 cm	I-T	ATS HKE044-10	7,00 €	11,00	1	145	10	25
25 cm	I-T	ATS HKE045-10	8,00 €	13,00	1	195	10	25
25 cm	I-T	ATS HKE046-10	9,00 €	17,00	1	192	10	25

Havuz savak ızgaraları 'I' tipi olup UV katkı PP'den mamüldür. Tek geçme ve çift geçme savak ızgaraları 'TS EN 13451-1' standartlarına uygundur. Izgaralar 138 kg basınca dayanıklı ve 16,8 çekme özelliğine sahiptir.

Overflow GRATING are made of 'I' type, It is made of UV added PP. Single and double joint GRATING are certificated by 'TS EN 13451-1' standards. It has a pressure resistance of 138 kg and a 16.8 pull grid.

P.P. Blok Model Savak Izgarası

P.P. Block Overflow Grating

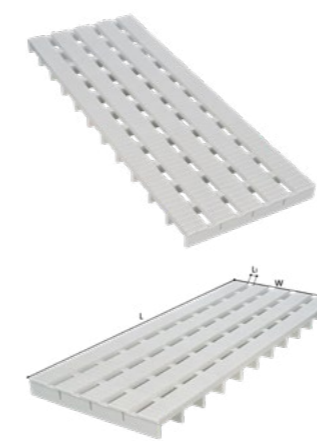

Malzeme Cinsi Description	Model	Kod Code	Fiyat (m) Price (m)	Kg /Koli Kg/Bag	L (mm)	L1 (mm)	H (mm)
Blok Izgara Blok Grating	I	ATS BLK020-M	7,00 €	11,40	500	10	25
Blok Köşe Parçası Blok Grating Corner	I	ATS BLK021-M	7,00 €	11,40	500	10	25

Blok tip savak ızgarası UV katkı PP'den mamüldür. EN 13451-1 standartlarına uygundur. 138 kg basınca dayanıklı ve 16,8 mm çekme payı vardır.

- Koli içerisinde 10 metre
- Kolay kurulum
- Zamandan ve işçilik maliyetinden tasarruf
- Estetik tasarım

Block Overflow Grating is made of UV added P.P. material. Conform EN 13451-1 Standard Pressure resistance is 138kg and pull grid is 16,8mm

- 1 Pack is 10 meters
- Easy installation by its block type
- Save time and labor cost
- Aesthetic design

P.P. Dalgalı Savak Izgarası

P.P Wavy Double Joint Overflow Grating



Malzeme Cinsi Description	Model	Kod Code	Fiyat (m) Price (m)	Kg /Koli Kg/Bag	Koli/Adet Box/Pcs
19,5cm	Dalgalı / Wavy	ATS HKE050	14,00 €	17,00	1
25,5cm	Dalgalı / Wavy	ATS HKE051	16,00 €	23,00	1

P.P. Tek Dizme Tırnaklı Savak Izgarası

P.P Grift Single Joint Overflow Grating



Malzeme Cinsi Description	Model	Kod Code	Fiyat (m) Price (m)	Kg /Koli Kg/Bag	Koli/Adet Box/Pcs
19,5cm	Tırnaklı / Grift	ATS HKE052	11,00 €	16,30	1
24,5cm	Tırnaklı / Grift	ATS HKE053	13,00 €	22,00	1

P.P. Modüler Savak Izgarası

P.P Rain Model Joint Overflow Grating



Malzeme Cinsi Description	Model	Kod Code	Fiyat (m) Price (m)	Kg /Koli Kg/Bag	Koli/Adet Box/Pcs
19,5cm	Tırnaklı / Rainy	ATS HKE150	17,00 €	16,30	1
24,5cm	Tırnaklı / Rainy	ATS HKE151	20,00 €	22,00	1

P.P. Modüler Savak Izgarası

P.P Flat Model Joint Overflow Grating

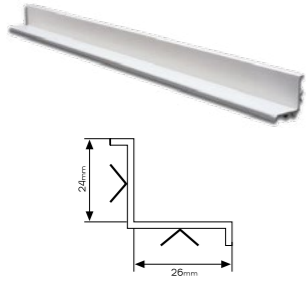

Malzeme Cinsi Description	Model	Kod Code	Fiyat (m) Price (m)	Kg /Koli Kg/Bag	Koli/Adet Box/Pcs
19,5cm	Düz / Flat	ATS HKE152	15,00 €	16,30	1
24,5cm	Düz / Flat	ATS HKE153	18,00 €	22,00	1

Izgara Kenar Profili
 Overflow Grating Edge Profile

Malzeme Cinsi Description	Kod Code	Fiyat (m) Price (m)	Kg /Koli Kg/Bag	Koli/m Box/m
24x26	ATS HKE054	1,50 €	25,00	100 mt

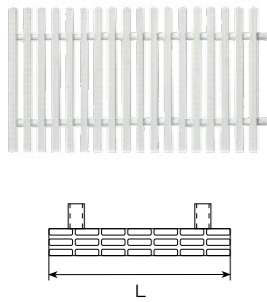
U-PVC Düz Tip Fitilli Havuz Savak Izgarası
 PP Single Joint Overflow Grating

Malzeme Cinsi Description	Kod Code	Fiyat (m) Price (m)	m /Koli m/Bag	h
110x140 mm	ATS HKE055	11,00 €	5	24
141x190 mm	ATS HKE056	14,00 €	5	24
191x240 mm	ATS HKE057	16,00 €	5	24
241x290 mm	ATS HKE058	18,00 €	5	24
291x340 mm	ATS HKE059	28,00 €	5	24
341x390 mm	ATS HKE060	32,00 €	5	24
391x440 mm	ATS HKE061	37,00 €	5	24
441x490 mm	ATS HKE062	42,00 €	5	24
1000x1000 mm	ATS HKE063	110,00 €	5	24

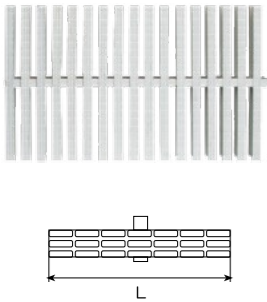
U-PVC Döner Tip Fitilli Havuz Savak Izgarası
 PP Double Joint Overflow Grating

Malzeme Cinsi Description	Kod Code	Fiyat (m) Price (m)	m /Koli m/Bag	h
110x140 mm	ATS HKE064	10,00 €	5	24
141x190 mm	ATS HKE065	13,00 €	5	24
191x240 mm	ATS HKE066	16,00 €	5	24
241x290 mm	ATS HKE067	18,00 €	5	24
291x340 mm	ATS HKE068	26,00 €	5	24
341x390 mm	ATS HKE069	31,00 €	5	24
391x440 mm	ATS HKE070	36,00 €	5	24
441x490 mm	ATS HKE071	41,00 €	5	24
1000x1000 mm	ATS HKE072	110,00 €	5	24

P.P. 45° - 90° Köşe Parçası
 P.P. 45° - 90° Corner Part

Malzeme Cinsi Description	Kod Code	Fiyat (Adet) Price (Pcs)	Kg /Adet Kg/Pcs	h
15cm 45°	ATS HKE073	7,00 €	0,10	145
15cm 90°	ATS HKE074	7,00 €	0,15	145
20cm 45°	ATS HKE075	8,00 €	0,20	195
20cm 90°	ATS HKE076	8,00 €	0,25	195
25cm 45°	ATS HKE077	9,00 €	0,45	245
25cm 90°	ATS HKE078	9,00 €	0,50	245
30cm 45°	ATS HKE079	10,00 €	0,60	300
30cm 90°	ATS HKE080	10,00 €	0,65	300

Kare Dip Emiş Izgarası (ABS)
 Square Main Drain (ABS)

Malzeme Cinsi Description	Kod Code	Fiyat (Adet) Price (Pcs)	Kg /Adet Kg/Pcs
200x200	ATS HKE081	12,00 €	0,50
250x250	ATS HKE082	14,00 €	0,86
300x300	ATS HKE154	18,00 €	1,20
410x410	ATS HKE083	87,00 €	1,60

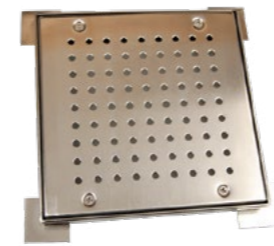
Kare Dip Emiş Izgarası
 Square Inox Main Drain

Malzeme Cinsi Description	Kod Code	Fiyat (Adet) Price (Pcs)	Kg /Adet Kg/Pcs
250x250	ATS HKE086	185,00 €	1,80
300x300	ATS HKE087	200,00 €	2,30
400x400	ATS HKE088	230,00 €	3,40
450x450	ATS HKE089	310,00 €	4,60
500x500	ATS HKE090	350,00 €	5,30
600x600	ATS HKE091	450,00 €	6,80
700x700	ATS HKE092	560,00 €	7,40

İsteğe göre AISI 316 malzemeden de yapılır. %20 fiyat farkı vardır.
 Can be produced of AISI 316 stainless steel if required. Price will increase more 20%.

Yuvarlak Dip Emiş Süzgeci (ABS)
 Round Main Drain (ABS)

Malzeme Cinsi Description	Kod Code	Fiyat (Adet) Price (Pcs)	Kg /Adet Kg/Pcs
Ø50-63	ATS HKE093	20,00 €	0,85
Ø50-63 (liner)	ATS HKE094	30,00 €	1,00

Kare Dip Süzgeci (ABS)
 Square Bottom Drain (ABS)

Malzeme Cinsi Description	Kod Code	Fiyat (Adet) Price (Pcs)	Kg /Adet Kg/Pcs
Ø63	ATS HKE095	33,00 €	1,40
Ø75	ATS HKE096	33,00 €	1,25
Ø90	ATS HKE097	33,00 €	1,35

Yandan Besleme Nozulu (ABS) Wall Side Inlet (ABS)



Malzeme Cinsi Description	Kod Code	Fiyat (Adet) Price (Pcs)	Kg /Adet Kg/Pcs
Ø63 Yandan Besleme Nozulu	ATS HKE098	2,50 €	0,10
Ø63 Yandan Besleme Nozulu (Liner)	ATS HKE099	17,00 €	0,19
Ø50 Yandan Besleme Nozulu	ATS HKE100	2,50 €	0,15
Ø63 Yandan Besleme Nozulu Dişli	ATS HKE155	6,50 €	0,15

Taban Besleme Nozulu (Debi Ayarlı - ABS) Bottom Inlet Nozzle (Multi-Flow Adjustable - ABS)



Malzeme Cinsi Description	Kod Code	Fiyat (Adet) Price (Pcs)	Kg /Adet Kg/Pcs
Ø63 Taban Besleme Nozulu	ATS HKE101	3,00 €	0,15
Ø63 Taban Besleme Nozulu (Liner)	ATS HKE102	19,00 €	0,20
Ø50 Taban Besleme Nozulu	ATS HKE103	3,00 €	0,15
Ø63 Taban Besleme Nozulu Dişli	ATS HKE156	9,50 €	0,15

Vakum Nozulu (ABS) Vacuum Nozzle (ABS)



Malzeme Cinsi Description	Kod Code	Fiyat (Adet) Price (Pcs)	Kg /Adet Kg/Pcs
Ø63 Vakum Nozulu	ATS HKE104	2,50 €	0,10
Ø63 Vakum Nozulu (Liner)	ATS HKE105	17,00 €	0,19
Ø50 Vakum Nozulu	ATS HKE106	2,50 €	0,15
Ø63 Vakum Nozulu Dişli	ATS HKE157	6,50 €	0,15

Taban Besleme Nozulu (ABS) Bottom Inlet Nozzle (ABS)



Malzeme Cinsi Description	Kod Code	Fiyat (Adet) Price (Pcs)	Kg /Adet Kg/Pcs
Ø63	ATS HKE107	2,50 €	0,10

Beton Ara Parçası (ABS) Concrete Wall Conduit (ABS)



Malzeme Cinsi Description	Kod Code	Fiyat (Adet) Price (Pcs)	Kg /Adet Kg/Pcs
Beton Ara Parçası - Dişli Concrete Wall Conduit - Threaded	ATS HKE108	10,00 €	0,40
Beton Ara Parçası - Yapıştırılmalı Concrete Wall Conduit - Glued	ATS HKE109	9,50 €	0,40

ABS den mamül, boru bağlantı tarafı Ø63 mm dıştan, Ø50 içten yapıştırılmalıdır. L=30 cm ön tarafında havuz perde kalıbına monte edilmek üzere vida yuva ve delikleri mevcuttur.
Made of ABS, Pipe connection side Ø63 external, Ø50 internal glued. L=30 cm In front of it has screw slots and holes to be installed on the pool wall mold.

İnce Geniş Ağızlı Skimmer ABS Slim Mouth Skimmer



Malzeme Cinsi Description	Kod Code	Fiyat (Adet) Price (Pcs)	Kg /Adet Kg/Pcs
İnce Geniş Ağızlı Skimmer Slim Mouth Skimmer	ATS HKE160	90,00 €	
İnce Geniş Ağızlı Skimmer Liner Slim Mouth Skimmer Liner	ATS HKE161	120,00 €	

Standart Ağızlı Skimmer ABS Standard Skimmer



Malzeme Cinsi Description	Kod Code	Fiyat (Adet) Price (Pcs)	Kg /Adet Kg/Pcs
Kare Kapaklı Skimmer Square Frame Skimmer	ATS HKE111	38,00 €	3,50
Kare Kapaklı Skimmer Liner Square Frame Skimmer Liner	ATS HKE112	70,00 €	3,85

ABS den mamül alt emiş bağlantıları 2", sepeti ve yüzer kapağı ile beraber.
Bottom drain connections 2" made of ABS, included in basket and floating lid.

Geniş Ağızlı Skimmer ABS Wide Mouth Skimmer



Malzeme Cinsi Description	Kod Code	Fiyat (Adet) Price (Pcs)	Kg /Adet Kg/Pcs
Kare Kapaklı Geniş Skimmer Square Frame Wide Mouth Skimmer	ATS HKE113	70,00 €	4,80
Kare Kapaklı Geniş Skimmer Liner Square Frame Wide Mouth Skimmer Liner	ATS HKE114	110,00 €	5,50

ABS den mamül alt emiş bağlantıları 2", sepeti ve yüzer kapağı ile beraber.
Bottom drain connections 2" made of ABS, included in basket and floating lid.

Taşma Gider Süzgeçleri Overflow Drainer



Malzeme Cinsi Description	Kod Code	Fiyat (Adet) Price (Pcs)	Kg /Adet Kg/Pcs
Ø63 Paslanmaz Çelik Stainless Steel Drainer	ATS HKE115	25,00 €	-
Ø75 Paslanmaz Çelik Stainless Steel Drainer	ATS HKE116	30,00 €	-
Ø90 Paslanmaz Çelik Stainless Steel Drainer	ATS HKE117	33,00 €	-
Ø110 Paslanmaz Çelik Stainless Steel Drainer	ATS HKE118	40,00 €	-
Ø110 Plastik Plastic Drainer -up to 110 Pipe	ATS HKE119	10,00 €	-

Sağa Kavisli Kaydırak Right Curved Slide



Malzeme Cinsi Description	Kod Code	Fiyat (Adet) Price (Pcs)	Kg /Adet Kg/Pcs	Uzunluk (m) Length (m)
Sağa Kavisli Kaydırak Right Curved Slide	ATS HKE121	2.000,00 €	83,00	3,55

Polyester ve fibreglas takviyeli, polyester basamaklı, paslanmaz çelik tutunma kolları, paslanmaz çeliklikten mamül destek kaidesi ekipmanları ile birlikte "Açık mavi renkli kaydırak."

Polyester and fiberglass reinforced with polyester step, stainless steel handrail, Complete with stainless steel supports and ladder in Light Blue Colour Slide.

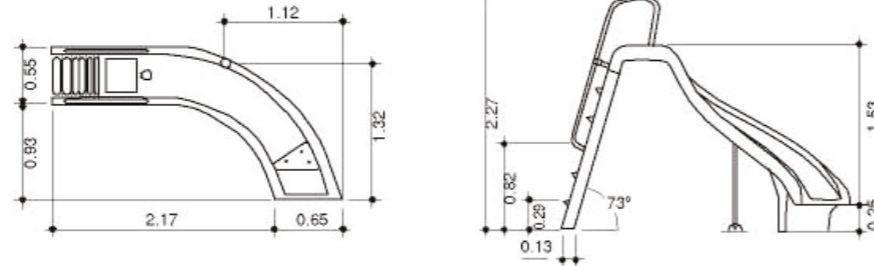

Düz Trampelen Flat Springboard



Malzeme Cinsi Description	Kod Code	Fiyat (Adet) Price (Pcs)	Kg /Adet Kg/Pcs	Uzunluk (m) Length (m)
2 mt	ATS HKE122	600,00 €	29,00	2,00
4 mt	ATS HKE123	1.500,00 €	50,00	4,00

Polyester ve fibreglastan mamül açık mavi renkli polyester ayağı ile birlikte.
Made of polyester and fiberglass in light blue colour with polyester leg.

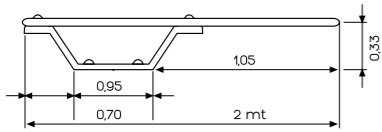

S Trampelen S Springboard



Malzeme Cinsi Description	Kod Code	Fiyat (Adet) Price (Pcs)	Kg /Adet Kg/Pcs	Uzunluk (m) Length (m)
S Trampelen / S Springboard	ATS HKE139	600,00 €	23,00	1,60

Polyester ve fibreglastan mamül S trampelen.
Made of polyester and fiberglass in light blue colour with polyester leg.

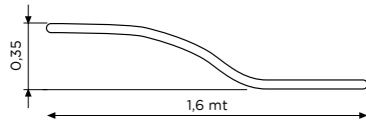

Mantar Şelaleler Mushroom Waterfalls



Malzeme Cinsi Description	Kod Code	Fiyat (Adet) Price (Pcs)	Kg /Adet Kg/Pcs
2000 mm / 150 m³/h - 6"	ATS HKE124	3.000,00 €	-
1600 mm / 80 m³/h - 4"	ATS HKE125	2.500,00 €	-
1000 mm / 40 m³/h - 2 1/2"	ATS HKE126	2.300,00 €	-

Polyester ve fibreglastan mamüldür. Fiyata mantarın ayağı dahil değildir.
Made of polyester and fiberglass, excluding mushroom leg.

Ayak Dezenfekte Havuzu Disinfection Pool For Feet

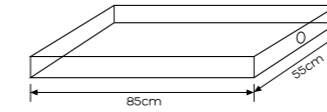

Malzeme Cinsi Description	Kod Code	Fiyat (Adet) Price (Pcs)	Kg /Adet Kg/Pcs	Uzunluk (cm) Length (cm)
Ayak Dezenfekte Havuzu	ATS HKE127	50,00 €	1,50	50x35x10cm
Ayak Dezenfekte Havuzu	ATS HKE128	80,00 €	2,90	70x45x10cm
Ayak Dezenfekte Havuzu	ATS HKE129	100,00 €	3,70	80x50x12cm
Ayak Dezenfekte Havuzu	ATS HKE130	150,00 €	5,00	120x70x12cm



Plastik Makine Dairesi Plastic Engine Room



Malzeme Cinsi Description	Kod Code	Fiyat (Adet) Price (Pcs)	Kg /Adet Kg/Pcs	Ürün Ebadı
Ø500-620	ATS HKE158	700,00 €	53,00	120x103x92 cm

Polyester Makine Dairesi Polyester Engine Room



Malzeme Cinsi Description	Kod Code	Fiyat (Adet) Price (Pcs)	Kg /Adet Kg/Pcs	Ürün Ebadı
Ø420-500-620	ATS HKE131	850,00 €	39,00	120x105x91 cm
Ø760-920	ATS HKE132	1.500,00 €	-	150x140x109 cm

Polyester Makine Dairesi ve Denge Deposu Kapakları Polyester Engine Room and Balance Tank Caps



Malzeme Cinsi Description	Kod Code	Fiyat (Adet) Price (Pcs)	Kg /Adet Kg/Pcs
60x60	ATS HKE135	270,00 €	9,75
75x75	ATS HKE136	320,00 €	11,55
90x90	ATS HKE137	360,00 €	21,50
100x100	ATS HKE138	430,00 €	26,50

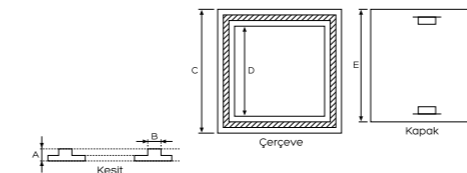

Kapaklar	A	B	C	D	E
60x60 cm	5 cm	4 cm	89,5 cm	65 cm	72,5 cm
75x75 cm	5 cm	4 cm	104 cm	80 cm	87,5 cm
90x90 cm	5 cm	4 cm	114,5 cm	91 cm	97,5 cm
100x100 cm	5 cm	4 cm	124,5 cm	100 cm	107,5 cm

Polyester Merdiven Polyester Ladder



Malzeme Cinsi Description	Kod Code	Fiyat (Adet) Price (Pcs)	Kg /Adet Kg/Pcs
Polyester Merdiven / Polyester Ladder	ATS HKE157	750,00 €	9,20

Liner havuzlar için polysterden mamül merdiven. Basamaklar kaymaz ve ahşap takviyelidir.
Made of polyester ladders have antişlip For liner pool

Capissi Şezlong

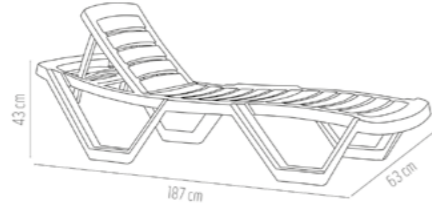

Malzeme Cinsi
Description
Capissi Şezlong

Kod
Code
ATS HKE160

Fiyat (Adet)
Price (Pcs)
100,00 €

Ürün Ebadı
43x187x63 cm

Capissi Şezlong

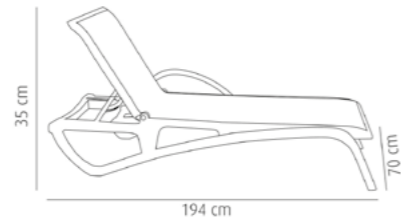

Malzeme Cinsi
Description
Atlantik Şezlong

Kod
Code
ATS HKE159

Fiyat (Adet)
Price (Pcs)
200,00 €

Ürün Ebadı
35x194x70 cm

HAVUZ İÇİ TEMİZLİK EKİPMANLARI POOL CLEANING EQUIPMENTS

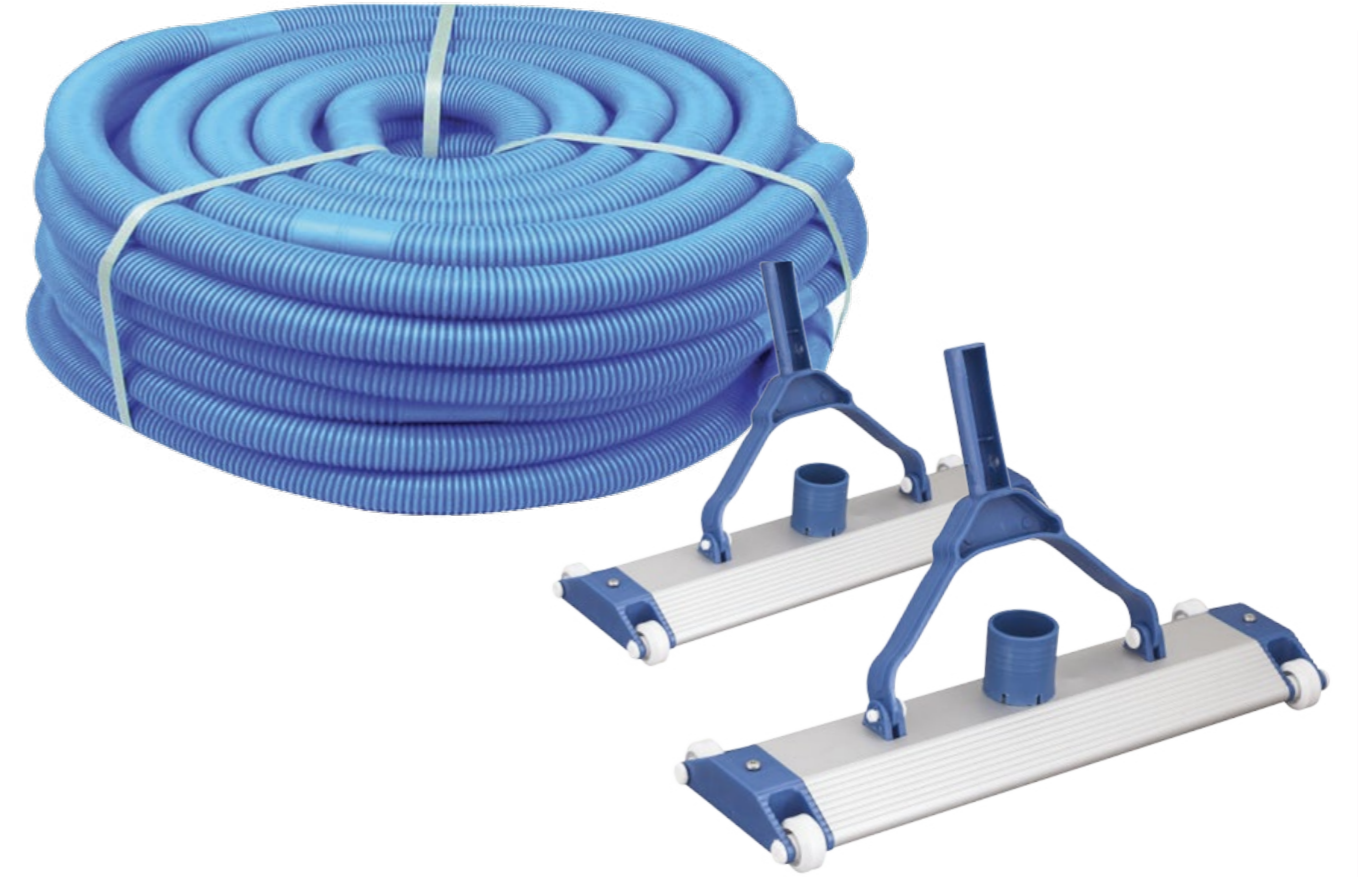

1 1/2"- 2" Flat Model Süpürge Parça Dağılımı
 1 1/2" - 2" Flat Model Vacuum Part Distribution

Süpürge Parçaları
 Vacuum Cleaner Parts

Malzeme Cinsi Description	Kod Code	Fiyat (Adet) Price (Pcs)	Kg /Adet Kg/Pcs
1 1/2" Süpürge Çatalı Vacuum Fork	ATS HTE001	6,00 €	1
2" Süpürge Çatalı Vacuum Fork	ATS HTE002	9,00 €	1
Süpürge Çatal Kelebek Vidası Paslanmaz Ç. Vacuum Fork with Butterfly Nut Stainless Steel	ATS HTE003	5,00 €	2
Süpürge Çatal Klipsi Vacuum Fork with Clip	ATS HTE004	3,00 €	3
Süpürge Çatal Bağlantı Parçası Vacuum Fork Connection Part	ATS HTE005	3,00 €	4
Süpürge Çatal Bağlantı Pimi Vacuum Fork Connection Pin	ATS HTE006	1,00 €	5
Süpürge Tekerliği Vacuum Roller	ATS HTE007	1,50 €	6
Süpürge Tekerlek Pimi Vacuum Roller Pin	ATS HTE008	1,00 €	7
Süpürge Yan Gövde (Tekerlek) Vacuum Side Body (Roller)	ATS HTE009	6,00 €	8
1 1/2" Süpürge Fırçası Vacuum Brush 1 1/2"	ATS HTE010	7,00 €	9
2" Süpürge Fırçası Vacuum Brush 2"	ATS HTE011	11,00 €	9
Süpürge Fırçası Yayı Vacuum Brush Spring	ATS HTE012	1,00 €	10
Süpürge Lastiği Vacuum Tire (1mt)	ATS HTE013	4,00 €	11
1 1/2" Süpürge Bağlantı Adaptörü Vacuum Connection Adapter 1 1/2"	ATS HTE014	5,00 €	12
2" Süpürge Bağlantı Adaptörü Vacuum Connection Adapter 2"	ATS HTE015	8,00 €	12

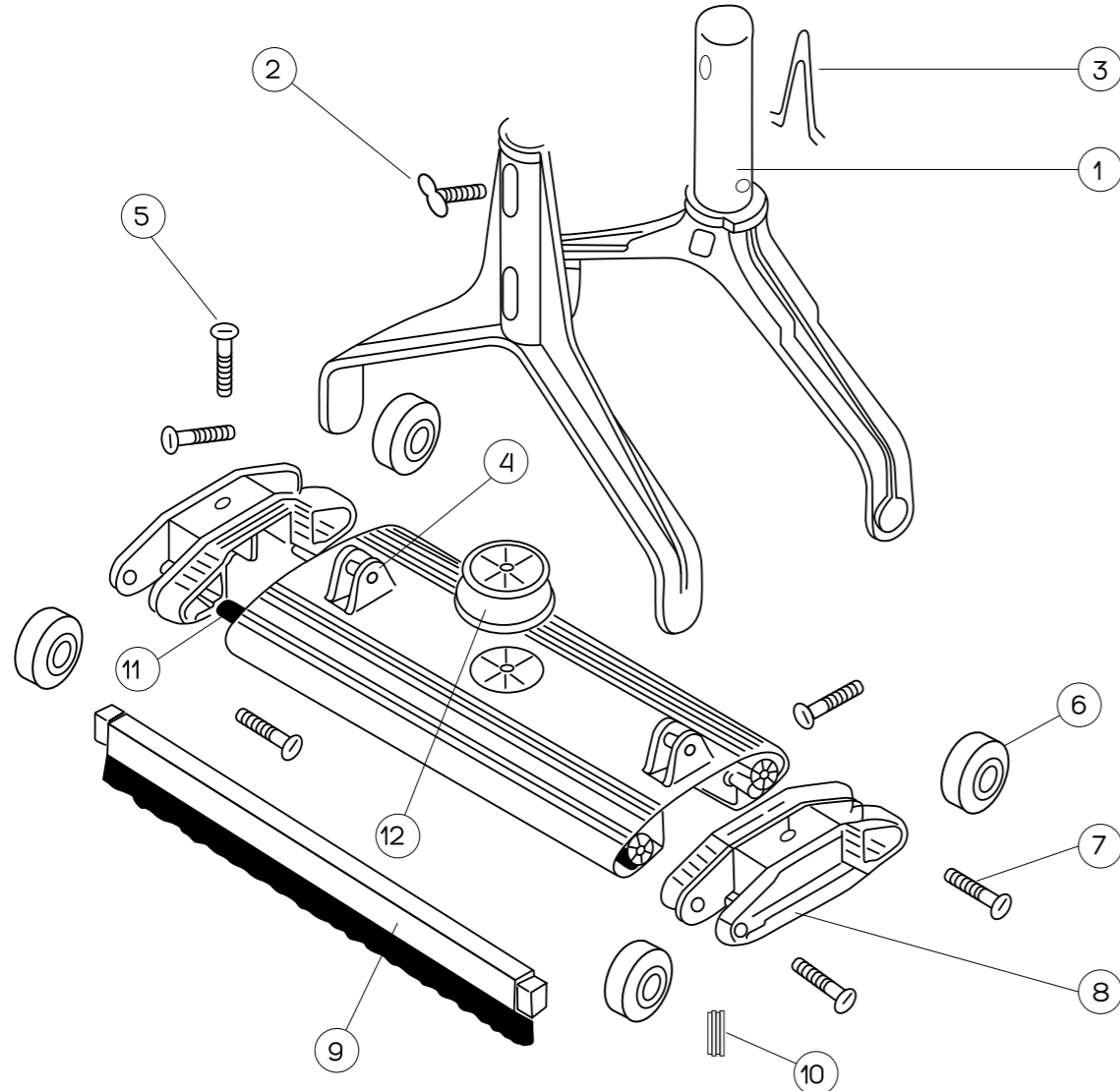
Alüminyum Flat Süpürgeler
 Aluminum Flat Type Vacuum

Malzeme Cinsi Description	Kod Code	Fiyat (Adet) Price (Pcs)	Kg /Adet Kg/Pcs	Koli/Adet Box/Pcs
1 1/2" Flat Model Süpürge (Klipsli Tip) 1 1/2" Flat Type Vacuum with Clip	ATS HTE016	40,00 €	2,45	1
2" Flat Model Süpürge (Klipsli Tip) 2" Flat Type Vacuum with Clip	ATS HTE017	50,00 €	2,78	1
1 1/2" Flat Model Süpürge (Civatalı Tip) 1 1/2" Flat Type Vacuum with Pin Bolt	ATS HTE018	45,00 €	2,45	1
2" Flat Model Süpürge (Civatalı Tip) 2" Flat Type Vacuum with Pin Bol	ATS HTE019	52,00 €	2,78	1
2" Flat Model Süpürge-60cm (Civatalı Tip) 2" Flat Type Vacuum 60 cm with Pin Bolt	ATS HTE020	85,00 €	3,50	1

Alüminyum Teleskopik Sap
 Aluminum Telescopic Handle

Malzeme Cinsi Description	Kod Code	Fiyat (Adet) Price (Pcs)	Kg /Adet Kg/Pcs	Koli/Adet Box/Pcs
2x2	ATS HTE021	30,00 €	1,22	1
2x2,5	ATS HTE022	32,00 €	1,36	1
2x3	ATS HTE023	45,00 €	1,85	1
3x3	ATS HTE024	80,00 €	2,25	1
4x3	ATS HTE059	120,00 €	3,50	1

Atlaspool EVA Hortumu
 AtlasPool EVA Vacuum Hose

Malzeme Cinsi Description	Kod Code	Fiyat (Adet) Price (Pcs)	Kg /Adet Kg/Pcs	Koli/Adet Box/Pcs
1 1/2"	ATS HTE025	4,00 €	-	1
2"	ATS HTE026	5,00 €	-	1

Vakum Hortumu
 Vacuum Hose

Malzeme Cinsi Description	Kod Code	Fiyat (Adet) Price (Pcs)	Kg /Adet Kg/Pcs	Koli/m Box/m
1 1/2"	ATS HTE031	5,00 €	9,00	50 m
2"	ATS HTE032	5,50 €	13,25	50 m

Hortum Adaptörleri
 Hose Adaptor

Malzeme Cinsi Description	Kod Code	Fiyat (Adet) Price (Pcs)	Kg /Adet Kg/Pcs	Koli/Adet Box/Pcs
1 1/2" - 2"	ATS HTE033	6,00 €	0,05	1
1 1/2"	ATS HTE035	4,00 €	0,03	1

Havuz Kepçesi

Leaf Scoop



Malzeme Cinsi Description	Kod Code	Fiyat (Adet) Price (Pcs)	Kg /Adet Kg/Pcs	Koli/Adet Box/Pcs
Derin Dip Havuz Kepçesi Geniş Deep Bottom Wide Leaf Scoop	ATS HTE036	14,00 €	0,050	1
Derin Dip Havuz Kepçesi Ekonomik Deep Bottom Economic Leaf Scoop	ATS HTE037	8,00 €	0,040	1

Kavisli Tip Fırça (Klipsli)

Curved Pool Brush With Clip



Malzeme Cinsi Description	Kod Code	Fiyat (Adet) Price (Pcs)	Kg /Adet Kg/Pcs	Koli/Adet Box/Pcs
26 cm Düz Tip Fırça Flat Type Pool Brush - 26 cm	ATS HTE038	7,00 €	0,15	1
45 cm Kavisli Fırça Curved Pool Brush - 45 cm	ATS HTE039	9,00 €	0,30	1
45 cm Kavisli Metal Saplı Fırça Curved Pool Brush with Metal Handle - 45 cm	ATS HTE040	14,00 €	0,50	1

Paslanmaz Fırça (Klipsli)

Pool Brush With Stainless Steel Bristles



Malzeme Cinsi Description	Kod Code	Fiyat (Adet) Price (Pcs)	Kg /Adet Kg/Pcs	Koli/Adet Box/Pcs
26 cm Cr-Ni Telli Uzun Yosun Fırçası Cr-Ni Wiry Long Algae Brush 26 cm	ATS HTE041	13,00 €	0,30	1
12,5 cm Cr-Ni Telli Uzun Yosun Fırçası Cr-Ni Wiry Short Algae Brush 12,5 cm	ATS HTE042	11,00 €	0,16	1

Köşe Fırçacı (Klipsli)

Corner Scoop (With Clip)



Malzeme Cinsi Description	Kod Code	Fiyat (Adet) Price (Pcs)	Kg /Adet Kg/Pcs	Koli/Adet Box/Pcs
Köşe Fırçası Corner Scoop	ATS HTE043	25,00 €	0,20	1

Termometre

Thermometer



Malzeme Cinsi Description	Kod Code	Fiyat (Adet) Price (Pcs)	Kg /Adet Kg/Pcs	Koli/Adet Box/Pcs
Termometre İpli-Ekonomik Large Thermometer 24 cm	ATS HTE044	6,00 €	0,05	1
Yüzer Tip Havuz Termometresi Round Thermometer	ATS HTE045	15,00 €	0,20	1

Dispenser

Dispenser



Malzeme Cinsi Description	Kod Code	Fiyat (Adet) Price (Pcs)	Kg /Adet Kg/Pcs	Koli/Adet Box/Pcs
Dispenser-Tablet Şamandırası Dispenser - Tablet Floater	ATS HTE046	12,00 €	0,33	1

Liner Tip Havuz Süpürgesi

Liner Type Pool Cleaner



Malzeme Cinsi Description	Kod Code	Fiyat (Adet) Price (Pcs)	Kg /Adet Kg/Pcs	Koli/Adet Box/Pcs
Liner Tip Üçgen Havuz Süpürgesi Liner Type Triangle Pool Cleaner	ATS HTE047	35,00 €	1,10	1

Liner Tip Havuz Süpürgesi (Ağırlık)

Liner Type Pool Cleaner



Malzeme Cinsi Description	Kod Code	Fiyat (Adet) Price (Pcs)	Kg /Adet Kg/Pcs	Koli/Adet Box/Pcs
Liner Tip Kelebek Model Havuz Süpürgesi Liner Type Butterfly Pool Cleaner	ATS HTE048	35,00 €	0,90	1

Liner Tip Havuz Süpürgesi (Tekerlekli Tip)

Liner Type Pool Cleaner (Wheeled Type)



Malzeme Cinsi Description	Kod Code	Fiyat (Adet) Price (Pcs)	Kg /Adet Kg/Pcs	Koli/Adet Box/Pcs
Liner Tip Havuz Süpürgesi (Tekerlekli Tip) Liner Type Pool Cleaner (Wheeled Type)	ATS HTE049	33,00 €	1,00	1

S250 Vakumlu Havuz Süpürgesi

S250 Vacuumed Pool Cleaner



Malzeme Cinsi Description	Kod Code	Fiyat (Adet) Price (Pcs)	Kg /Adet Kg/Pcs	Koli/Adet Box/Pcs
S250 Vakumlu Havuz Süpürgesi S250 Vacuumed Pool Cleaner	ATS HTE058	500,00 €	6,50	1

Lil Shark Robot Süpürge

Lil Shark Robotic Cleaner



Malzeme Cinsi Description	Kod Code	Fiyat (Adet) Price (Pcs)	Kg /Adet Kg/Pcs	Koli/Adet Box/Pcs
Robot Süpürge Manuel-GW 800 Robotic Manual Cleaner - GW 800	ATS HTE051	500,00 €	5,45	1

Pool Shark Robot Süpürge

Pool Shark Robotic Cleaner



Malzeme Cinsi Description	Kod Code	Fiyat (Adet) Price (Pcs)	Kg /Adet Kg/Pcs	Koli/Adet Box/Pcs
Robot Süpürge Manuel - GW 7500 Robotic Manual Cleaner - GW 7500	ATS HTE052	500,00 €	6,15	1

Vortex™ 1 Robot Süpürge

Wartex TM 1 Robotic Cleaner



Malzeme Cinsi Description	Kod Code	Fiyat (Adet) Price (Pcs)	Kg /Adet Kg/Pcs	Koli/Adet Box/Pcs
Wartex TM 1 Robot Süpürge - 15 m kablolu Wartex TM 1 Robotic Cleaner	ATS HTE053	955,00 €	8,80	1

10x5 mt kadar havuzları temizler. Sadece zemin temizliği yapar. Temizleme süresi sabit 2 saattir.
Cleans pools up to 10x5 mt. It only cleans the floor. The cleaning time is fixed 2 hours.

VOTEX TEMİZLEME ROBOT ÖZELLİKLERİ

VOTEX CLEANING ROBOT FEATURES

- Tüm havuz şekilleri ve tüm yüzeyler için kullanıma uygundur.
- Susuz ortamda otomatik motor korumafonksiyonu vardır.
- Vortex etkisi filtre içinde son derece güçlü bir girdap yaratır.
- Tortular süspansiyon içinde kalır ve böylece filtrenin tıkanması engellenir.
- Sonuç olarak tüm temizlik işlemi süresince sabit güç ve emiş sağlar.
- Ayrıca, bu benzersiz motor konumu, kullanımı kolay filtre odacığına sahip ilk havuz temizleyicisini geliştirmiştir.
- Tortular cihazın üst tarafında bulunan ayrı bir odacığa toplanır.
- Sadece tek bir düğmeye basarak boşaltabilirsiniz.
- Bu sayede filtre hızlı ve hijyenik olarak temizlenir.
- Garanti süresi 2 yıldır.
- Suitable for use for all pool shapes and all surfaces.
- Automatic motor protection is available in an aqueous environment.
- The Vortex effect creates an extremely strong vortex within the filter.
- The sediments remain in the suspension, thereby preventing the filter from clogging.
- As a result, it provides constant power and suction during the entire cleaning process.
- Also, this unique engine position, easy-to-use filter has developed the first pool cleaner with a chamber.
- The deposits are collected in a separate chamber located at the top of the device.
- You can empty it at the push of a button.
- In this way, the filter is cleaned quickly and hygienically.
- The warranty period is 2 years.



Vortex™ RV5400 Robot Süpürge

Wartex TM RV 5400 Robotic Cleaner



Malzeme Cinsi Description	Kod Code	Fiyat (Adet) Price (Pcs)	Kg /Adet Kg/Pcs	Koli/Adet Box/Pcs
Wartex TM RV 5400 Robot Süpürge - 18 m kablolu Wartex TM RV 5400 Robotic Cleaner	ATS HTE054	2.500,00 €	19,20	1

12x6 mt ye kadar havuzları temizler. Uzaktan kumandası yoktur.
Cleans pools up to 12x6 mt. It doesn't have a remote control.

İKİ TEMİZLİK PROGRAMI

TWO CLEANING PROGRAMS

- Zemin 1,5 saatte, zemin ile yan duvarları 2,5 saatte temizler.
- 4x4 çeker tekerler ile daha güçlü hareket eder.
- Susuz ortamda otomatik motor koruma fonksiyonu vardır.
- Taşıma arabası, kontrol ünitesi, filtre ve mini fırçasıyla verilir.
- Garanti süresi 3 yıldır.
- It cleans the floor in 1.5 hours, the floor and side walls in 2.5 hours.
- It moves more strongly with 4x4 wheel wheels.
- There is an automatic motor protection function in an aqueous environment.
- Supplied with carriage, control unit, filter and mini brush.
- The warranty period is 3 years.



Vortex™ RV 5500 Robot Süpürge

Wartex TM RV 5500 Robotic Cleaner



Malzeme Cinsi Description	Kod Code	Fiyat (Adet) Price (Pcs)	Kg /Adet Kg/Pcs	Koli/Adet Box/Pcs
Wartex TM RV 5400 Robot Süpürge - 21 m kablolu Wartex TM RV 5500 Robotic Cleaner	ATS HTE055	2.950,00 €	19,20	1

16x8 mt ye kadar havuzları temizler. Uzaktan kumandası vardır.
Cleans pools up to 16x8 mt. It has a remote control.

ÜÇ TEMİZLİK PROGRAMI

THREE CLEANING PROGRAMS

- Zemin ile yan duvarlar, su seviyesi çizgisini temizler.
- 4x4 çeker tekerler ile daha güçlü hareket eder.
- Susuz ortamda otomatik motor koruma fonksiyonu vardır.
- Kinetik enerji ile çalışan uzaktan kumandalı.
- Filtre dolduğunda uyarma özelliği.
- Yedi güne kadar ayarlanabilir temizlik süresi mevcuttur.
- Taşıma arabası, kontrol ünitesi, filtre ve mini fırçasıyla verilir.
- Garanti süresi 3 yıldır.
- The floor and side walls clean the water level line.
- It moves more strongly with 4x4 wheel wheels.
- There is an automatic motor protection function in an aqueous environment.
- Remote control powered by kinetic energy.
- With warning when the filter is full.
- An adjustable cleaning time of up to seven days is available.
- Supplied with carriage, control unit, filter and mini brush.
- The warranty period is 3 years.

Vortex™ RV 5600 Robot Süpürge

Wartex TM RV 5600 Robotic Cleaner



Malzeme Cinsi Description	Kod Code	Fiyat (Adet) Price (Pcs)	Kg /Adet Kg/Pcs	Koli/Adet Box/Pcs
Wartex TM RV 5600 Robot Süpürge - 25 m kablolu Wartex TM RV 5600 Robotic Cleaner	ATS HTE057	3.060,00 €	22,50	1

20x10 mt ye kadar havuzları temizler. Panel üzerinde uzaktan kumandası vardır.
Cleans pools up to 20x10 mt. The panel has a remote control.

RV 5600 ROBOT SÜPÜRGE ÖZELLİKLERİ

RV 5600 ROBOT VACUUM CLEANER FEATURES

Zodiac araştırma merkezinde geliştirilen özel mikro işlemci, havuzunuzun boyutlarına ve şekline göre robotu yönlendirir ve temizlik için gereken süreyi otomatik olarak hesaplar. Yanlış bir defa programlamanız yeter. Havuzun tüm özelliklerini hafızasında saklar. Tüm havuz şekilleri ve tüm yüzeyler için kullanıma uygundur. Optimum sürede hassas temizlik için bilgisayarla yönlendirme özelliği, yüksek emiş gücü, etkili ve kısa süreli temizlik periyotları için 3 adet yüksek performanslı motor. Uzaktan kumandasında; Havuzun belirli kısımlarını temizlemek için otomatik veya uzaktan kumanda modu, temizlenecek yüzeyleri seçmek için yalnızca taban veya taban ve yan duvarlar seçeneği vardır. Kalan temizlik süresini gösteren dijital ekran. Fırçalar havuz tabanı, yan duvarlar, su altı platformu ve su yüzeyinin en iyi şekilde temizlenmesi için otomatik olarak ayarlanır. Geniş 20 mikronluk filtre torbası en küçük birikinti parçalarını bile bırakmaz. Geniş temizleme eni (28 cm) tek bir hamlede mümkün olan en fazla birikintinin temizlenmesini sağlar. Patentli dişli aktarım sistemi, Is-Track System: Daha fazla güvenilirlik ve hassasiyet sağlar. Tutukluk veya su dışında çalışma durumunda elektronik motor koruma özelliği. Platform sistemi: Robot havuz kenarındaki platforma çıktığında otomatik olarak suya geri döner. Temizlik süresi 30 dakika aralıklarla 6 saate kadar sürer. Alüminyum taşıma arabası, kumanda kutusu ve bir kablo ile. Garanti süresi 2 yıldır.

Developed at the Zodiac research center, the dedicated microprocessor guides the robot based on the size and shape of your pool and automatically calculates the time required for cleaning. You only have to program it once. It stores all the features of the pool in its memory. Suitable for use for all pool shapes and all surfaces. 3 high-performance motors for computer orientation, high suction power, effective and short-term cleaning periods for precise cleaning in optimum time. On the remote control; There is an automatic or remote control mode to clean certain parts of the pool, and only the base or base and side walls option to select surfaces to clean. Digital easing showing the remaining cleaning time. Brushes are automatically adjusted to ensure the best cleaning of the pool floor, side walls, underwater platform and water surface. The large 20-micron filter bag does not leave even the smallest pieces of puddle. Wide cleaning width (28 cm) ensures that as many deposits as possible are cleaned in a single move. Patented gear transfer system, Is-Track System: Provides greater reliability and precision. Electronic motor protection in case of jamming or operation outside of water. Platform system: Automatically returns to the water when the robot goes to the poolside platform. The cleaning time lasts up to 6 hours with a interval of 30 minutes. With an aluminum trolley, a control box and a cable. The warranty period is 2 years.



Not / Note

DEZENFEKSİYON SİSTEMLERİ DISINFECTION SYSTEMS



PANELLİ OTOMATİK KONTROL CİHAZLARI

AUTOMATIC CONTROL SYSTEMS ON PANEL

Dahili Dozaj Pompalı PH-RH Ölçüm Cihazı (1000 m³ 'e kadar)

PH-RH Measurement Device with Pumps (until 1000 m³ pool)



Malzeme Cinsi Description	Kod Code	Fiyat (Adet) Price (Pcs)	Kg /Adet Kg/Pcs	Koli/Adet Box/Pcs
WPHRHD 03 10/ Otomatik Kontrol Cihazı WPHRHD 03 10 Automatic Control Device	ATS HDS001	1.260,00 €	8,50	1

Asit (pH) ve dezenfektan (ORP) dozaj pompalı dijital oransal regülatör. Ölçüm aralığı 0-14 pH ve 0-1000 mV. Stand-by girişi, her pompada seviye kontrolü. İki işletme modu; Mod 1; klor ve asit manuel besleme; Mode 2; pH'a göre asit ve klor (ph öncelikli) besleme. Dozaj pompası kapasitesi 10 lt/h 3 bar. Arkadan aydınlatmalı LCD ekran. PVDF pompa kafası. 2 adet NFIL60 Filtre, 2 adet PEA Prob tutucu, 1 Adet EPHS pH Probu, 1 Adet ERHS Redoks Probu (ORP), 4 Adet Kalibrasyon sıvıları dahildir.

Digital proportional regulator with acid (pH) and disinfectant (ORP) dosage pump. Measuring range 0-14 pH and 0-1000 mV. Stand-by inlet, level control on each pump. Two operation mode: Mode 1; manual feed of chlorine and acid; Mode 2; acid and chlor (pH firstly) feed by pH. The capacity of dosing pumps 10 lt/h 3 bar. Backlighted LCD screen. PVDF pump head. It included 2 Piece NFIL60 filter. 2 Piece PEA Prob standpat, 1 Piece EPHS pH prob, 1 Piece ERHS Redoks prob, 4 Piece Calibration Liquids.

PH-RH Metreli Dozaj Pompalı Ölçüm Cihazı (2000 m³'e kadar)

Measurement Device with PH-RH Metered Dosage Pumps (until 2000 m³ pool)



Malzeme Cinsi Description	Kod Code	Fiyat (Adet) Price (Pcs)	Kg /Adet Kg/Pcs	Koli/Adet Box/Pcs
VPO 02 17/ Otomatik Kontrol Cihazı VPO 02 17 / Automatic Control Device	ATS HDS002	1.863,00 €	9,90	1

Asit (pH) ve dezenfektan (ORP) dozaj pompalı dijital oransal regülatör. Ölçüm aralığı 0-14 pH ve 0-1000 mV. Stand-by girişi, her pompada seviye kontrolü. İki işletme modu; Mod 1; klor ve asit manuel besleme; Mode 2; pH'a göre asit ve klor (ph öncelikli) besleme. Dozaj pompası kapasitesi 10 lt/h 3 bar. Arkadan aydınlatmalı LCD ekran. PVDF pompa kafası. 2 adet NFIL60 Filtre, 2 adet PEA Prob tutucu, 1 Adet EPHS pH Probu, 1 Adet ERHS Redoks Probu (ORP), 4 Adet Kalibrasyon sıvıları dahildir.

VPH 02 17 4 00 00 / 2 bar 17 lt/h. It included inside pH meter with proportional control, digital indication, floater inlet and level floater, 220 VAC, 16 W, PVDF, suction filter, discharge injection nozzle, 4x6 suction-discharge-degassing hose. VRH 02 17 4 00 00 / 2 bar 17 lt/h. It included inside redoxmeter (ORP) with proportional control, digital indication, floater inlet and level floater, 220 VAC, 16 W, PVDF, suction filter, discharge injection nozzle, 4x6 suction-discharge-degassing hose. It included 2 Piece NFIL60 filter, 2 Piece PEA Prob standpat, 1 Piece EPHS pH prob, 1 Piece ERHS Redoks prob (ORP), 4 Piece Calibration Liquids.

PH/RH Ölçüm Cihazı

PH-RH Measurement Device



Malzeme Cinsi Description	Kod Code	Fiyat (Adet) Price (Pcs)	Kg /Adet Kg/Pcs	Koli/Adet Box/Pcs
LPHRH 04 14 PH ve 0-1000 mV / Ölçüm Cihazı LDPHRH04 14 PH and 0-1000 mV Measuring Device	ATS HDS003	1.430,00 €	7,70	1

LPHRH / 0-14 pH ve 0-1000 mV Ölçüm aralıklı, on/off, çift display (7satri LED ekran) pH ve redoks ölçüm cihazı. IP 65 koruma. 2 Adet NFIL60 Filtre, 2 Adet PEA Prob tutucu, 1 Adet EPHS pH Probu, 1 Adet ERHS Redoks Probu (ORP), 4 Adet Kalibrasyon sıvıları dahildir.

LDPHRH/The pH RH measurement device; measuring range 0-14 pH and 0-1000 mV, LED screen, redox measurement device. IP 65 protection. It included 2 Piece NFIL60 filter, 2 Piece PEA Prob standpat, 1 Piece EPHS pH prob, 1 Piece ERHS Redoks prob (ORP), 4 Piece Calibration Liquids.

Dahil PH/RH Metreli Dozaj Pompalı Ölçüm Cihazı

Measurement Device with Inside pH/RH Metered Dosing Pump



Malzeme Cinsi Description	Kod Code	Fiyat (Adet) Price (Pcs)	Kg /Adet Kg/Pcs	Koli/Adet Box/Pcs
VPO 02 17 Dahilli PH / RH Metreli VPO 02 17 Internal PH/RH Metered Measuring Device w/Dosage Pumps	ATS HDS004	954,50 €	7,70	1

2 bar 17 lt/h, dahilli pH metre ile oransal kontrollü, dijital göstergeli. Şamandıra girişli ve seviye şamandıralı, 220 VAC, 16W. PVDF pompa kafası. emiş filtresi, basma ejektörü, 4x6 emme-basma-degassing hortumları ile komple. 1 Adet NFIL60 Filtre, 1 adet PEA Prob tutucu, 1 adet EPHS pH Probu, 3 adet kalibrasyon sıvıları dahildir.

LPHRH/The pH RH measurement device; measuring range 0-14 pH and 0-1000 mV, on/off, twofold display (7 line LED screen). IP 65 protection. It included 2 Piece NFIL60 filter, 2 Piece PEA Prob standpat, 1 Piece EPHS pH prob, 1 Piece ERHS Redoks prob (ORP), 4 Piece Calibration Liquids.

Malzeme Cinsi Description	Kod Code	Fiyat (Adet) Price (Pcs)	Kg /Adet Kg/Pcs	Koli/Adet Box/Pcs
VPO 02 17 Dahilli PH / RH Metreli VPO 02 17 Internal PH/RH Metered Measuring Device w/Dosage Pumps	ATS HDS005	943,00 €	7,70	1

2 bar 17 lt/h. dahilli redoksmetre (ORP) ile oransal kontrollü, dijital göstergeli, şamandıra girişli ve seviye şamandıralı, 220 VAC, 16 W PVDF pompa kafası, emiş filtresi, basma ejektörü, 4x6 emme-basma-degassing hortumları ile komple 1 Adet NFIL60 Filtre, 1 adet PEA Prob tutucu, 1 adet ERHS Redoks Probu (ORP), 1 adet kalibrasyon sıvısı dahildir.

2 bar 17 lt/h. It included inside redoxmeter (ORP) with proportional control, digital indication, indication, floater inlet and level floater, 220 VAC, 16 W, PVDF pump head, suction filter, discharge injection nozzle, 4x6 suction-discharge-degassing hose. It included 1 Piece NFIL60 filter, 1 Piece PEA Prob standpat, 1 Piece ERHS redoks prob (ORP), 1 Piece Calibration Liquids.

Dahil PH/RH Metreli Dozaj Pompalı Ölçüm Cihazı

PH-RH Measurement Device With Pumps (until 1000 m³ pool)



Malzeme Cinsi Description	Kod Code	Fiyat (Adet) Price (Pcs)	Kg /Adet Kg/Pcs	Koli/Adet Box/Pcs
WPHRHD 03 10 / Otomatik Kontrol Cihazı WPHRHD 03 10 Internal pH/RH Automatic Control Device	ATS HDS006	840,00 €	3,00	1

Asit (pH) ve dezenfektan (ORP) dozaj pompalı dijital oransal regülatör. Ölçüm aralığı 0-14 pH ve 0-1000 mV. Stand-by girişi, her pompada seviye kontrolü. İki işletme modu; Mod 1; klor ve asit manuel besleme; Mode 2; pH'a göre asit ve klor (ph öncelikli) besleme. Dozaj pompası kapasitesi 10lt/h 3 bar. Arkadan aydınlatmalı LCD ekran. PVDF pompa kafası.

Digital proportional regulator with acid (pH) and disinfectant (ORP) dosage pump. Measuring range 0-14 pH and 0-1000 mV. Stand-by inlet, level control on each pump. Two operation mode: Mode 1; manual feed of chlorine and acid; Mode 2; acid and chlor (pH firstly) feed by pH. The capacity of dosing pumps 10 lt/h 3 bar. Backlighted LCD screen. PVDF pump head.

OTOMATİK KONTROL CİHAZLARI

AUTOMATIC CONTROL DEVICE

Dahili PH Metreli Dozaj Pompalı Ölçüm Cihazı

Measurement Device With Inside pH/RH Metered Dosing Pump



Malzeme Cinsi Description	Kod Code	Fiyat (Adet) Price (Pcs)	Kg /Adet Kg/Pcs	Koli/Adet Box/Pcs
VPO 02 Bar 17 lt/h Internal pH/RH Metered Measuring Device	ATS HDS007	867,00 €	2,20	1
VPO 03 Bar 10 lt/h Dahilli PH Metreli Ölçüm Cihazı VPO 03 Bar 10 lt/h Internal pH/RH Metered Measuring Device	ATS HDS008	743,00 €	2,20	1
VPO 07 Bar 06 lt/h Dahilli PH Metreli Ölçüm Cihazı VPO 07 Bar 06 lt/h Internal pH/RH Metered Measuring Device	ATS HDS009	743,00 €	2,20	1

Dahilli pH metre ile oransal kontrollü, dijital göstergeli, şamandıra girişli ve seviye şamandıralı, 220 VAC, 16W, PVDF pompa kafası, emiş filtresi, basma ejektörü, 4x6 emme-basma-degassing hortumları ile komple.

It included inside pH / RH meter with proportional control, digital indication, floater inlet and level floater, 220 VAC, 16 W, PVDF pump head, suction filter, discharge injection nozzle, 4x6 suction-discharge-degassing hose.

PH/RH Ölçüm Cihazı

pH-RH Measurement Device



Malzeme Cinsi Description	Kod Code	Fiyat (Adet) Price (Pcs)	Kg /Adet Kg/Pcs	Koli/Adet Box/Pcs
LPHRH 04 14 PH ve 0-1000 mV / Ölçüm Cihazı LDPHRH04 14 PH and 0-1000 mV Measuring Device	ATS HDS013	1.133,00 €	2,00	1

LPHRH / 0-14 pH ve 0-1000 mV ölçüm aralıklı, on/off, çift display (7satri LED ekran) pH ve redoks ölçüm cihazı. IP 65 koruma.

LDPHRH/ Measuring range 0-14 pH and 0-1000 mV, LCD Screen, PH and redox (7 line LED screen). IP 65 protection.

FCE / FCLE Dozaj Pompası

FCE / FCLE Dosing Pump



Malzeme Cinsi Description	Kod Code	Fiyat (Adet) Price (Pcs)	Fiyat (Adet) Price (Pcs)	Kg /Adet Kg/Pcs
FCE 05 05 / 5 bar 5 lt/h - 2,5 bar 7 lt/h - 1 bar 8 lt/h	ATS HDS014	197,00 €	275,00 €	2,20
FCE 07 03 / 7 bar 3 lt/h - 3,5 bar 4 lt/h - 1 bar 6 lt/h	ATS HDS015	197,00 €	275,00 €	2,20
FCE 12 1,5 / 12 bar 1.5 lt/h - 6 bar 2.5 lt/h - 1 bar 5 lt/h	ATS HDS016	197,00 €	275,00 €	2,20

On-off kumandalı, manuel frekans ile debi ayarlı, 1/10 divider modu, 220 VAC, 16W, analog kontrollü, polipropilen, emiş filtresi, basma ejektörü, 4x6 emme-basma-degassing hortumları ile komple.

FCE DOSING PUMP WITHOUT SWITCH On-Off control, flow control with manual frequency, 1/10 divider mode, 220 VAC, 16W, analogue control, Polypropylene, suction filter, discharge injection nozzle, 4x6 suction-discharge-degassing hose. FCLE DOSING PUMP WITH SWITCH On-Off control, flow control with manual frequency, 1/10 divider mode, floater inlet and level floater, 220 VAC, 16 W, analogue control, Polypropylene pump head, suction filter, discharge injection nozzle, 4x6 suction-discharge-degassing hose.

VCO / VCL Dozaj Pompası

VCO / VCL Dosing Pump



Malzeme Cinsi Description	Kod Code	Fiyat (Adet) Price (Pcs)	Fiyat (Adet) Price (Pcs)	Kg /Adet Kg/Pcs
VCO 03 10 / 3 bar 10 lt/h - 2 bar 11 lt/h - 1 bar 13 lt/h	ATS HDS017	307,00 €	448,50 €	2,20
VCO 02 17 / 2 bar 17 lt/h - 1 bar 18 lt/h - 0 bar 19 lt/h	ATS HDS018	420,00 €	573,00 €	2,20
VCO 05 10 / 5 bar 10 lt/h - 2 bar 13 lt/h - 1 bar 15 lt/h	ATS HDS019	363,00 €	512,00 €	2,20
VCO 10 10 / 10 bar 10 lt/h - 5 bar 13 lt/h - 1 bar 20 lt/h	ATS HDS020	420,00 €	573,00 €	2,20
VCO 07 06 / 7 bar 6 lt/h - 3 bar 9 lt/h - 1 bar 12 lt/h	ATS HDS021	307,00 €	448,50 €	2,20
VCO 15 04 / 15 bar 4 lt/h - 5 bar 7,5 lt/h - 1 bar 12 lt/h	ATS HDS022	363,00 €	512,00 €	2,20
VCO 18 02 / 18 bar 2 lt/h - 6 bar 4 lt/h - 1 bar 8 lt/h	ATS HDS023	363,00 €	512,00 €	2,20

On-off kumandalı, manuel frekans ile debi ayarlı, 1/10 divider modu, 220 VAC, 16-22W, analog kontrollü, Polipropilen, emiş filtresi, basma ejektörü, 4x6 / 4x8 / 6x8 emme-basma-degassing hortumları ile komple.

VCO DOSING PUMP WITHOUT SWITCH On-Off control, flow control with manual frequency, 1/10 divider mode, 220 VAC, 16W, analogue control, Polypropylene, suction filter, discharge injection nozzle, 4x6 / 4x8 / 6x8 suction-discharge-degassing hose. VCL DOSING PUMP WITH SWITCH On-Off control, flow control with manual frequency, 1/10 divider mode, floater inlet and level floater, 220 VAC, 16 W, analogue control, PVDF pump head, suction filter, discharge injection nozzle, 4x6 / 4x8 / 6x8 suction-discharge-degassing hose.

TCO / TCL Dozaj Pompası

TCO / TCL Dosing Pump



Malzeme Cinsi Description	Kod Code	Fiyat (Adet) Price (Pcs)	Fiyat (Adet) Price (Pcs)	Kg /Adet Kg/Pcs
TCO 03 30 / 3 bar 30 lt/h - 1 bar 35 lt/h - 0 bar 15 lt/h	ATS HDS024	726,00 €	937,00 €	5,70
TCO 04 20 / 4 bar 20 lt/h - 1.5 bar 25 lt/h - 0 bar 38 lt/h	ATS HDS025	575,00 €	770,00 €	5,70
TCO 01 50 / 1 bar 50 lt/h - 0 bar 57 lt/h	ATS HDS026	726,00 €	937,50 €	5,70

3 bar 30 lt/h ,On-off kumandalı, manuel frekans ile debi ayarlı, 220 VAC, 27W, analog kontrollü, duvar montajına uygun, mikropros- sesör teknoloji, PVDF Pompa Kafası, emiş filtresi, basma ejektörü, 6x8 / 8x12 emme-basma degassing hortumları ile komple.

TCO WITHOUT SWITCH 3 bar 30 lt/h. On-Off control, flow control with manual frequency, 220 VAC, 27W, analogue control, usable for wall installation, microprocessor technology, PVDF pump head, suction filter, discharge injection nozzle, 6x8/ 8x12 suction-discharge-degassing hose. TCL WITH SWITCH On-Off control, flow control with manual frequency, floater inlet and level floater, 220 VAC, 27W, usable for wall installation, microprocessor technology, analogue.

YEDEK ÜRÜNLER SUBSTITUTE PRODUCTS

PH Probu - Redoks Probu PH Prob - Redox Prob

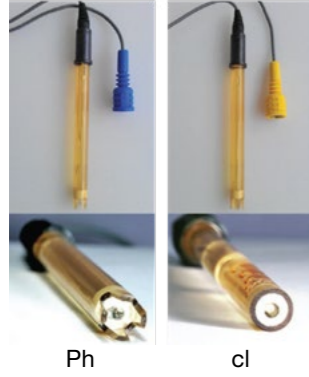

Malzeme Cinsi Description	Kod Code	Fiyat (Adet) Price (Pcs)	Kg /Adet Kg/Pcs	Koli/Adet Box/Pcs
EPHS 0,8 mt Kablolu - Ph Probu EPHS 0,8 mt with cable- Ph Prob	ATS HDS040	140,00 €		1
EPHM 4,5 mt Kablolu - Ph Probu EPHM 4,5 mt with cable- Ph Prob	ATS HDS041	170,00 €		1
EPHL 15,0 mt Kablolu - Ph Probu EPHL 15,0 mt with cable- Ph Prob	ATS HDS042	204,00 €		1
ERHS 0,8 mt Kablolu - Cl Probu ERHS 0,8 mt with cable- Cl Prob	ATS HDS043	147,00 €		1
EPHM 4,5 mt Kablolu - Cl Probu EPHM 4,5 mt with cable- Cl Prob	ATS HDS044	180,00 €		1
EPHL 15,0 mt Kablolu - Cl Probu EPHL 15,0 mt with cable- Cl Prob	ATS HDS045	207,00 €		1

Ph Probu : 7bar-70 C (3,5bar-80 C), 0-14 ph ölçüm aralıklı. epoksi gövdeli. BNC bağlantılı. 12mm çapında, min.100 mikro siemens çalışma iletkenlikli.
Redoks Probu : 7bar-70 C (3,5bar-80 C),0-1000 mV ölçüm aralıklı,epoksi gövdeli. BNC bağlantılı, 12mm çapında.

PH Prob: 7 bar/ 70 °C (3,5 bar-80 °C), Measuring range 0-14 pH, epoxy body, BNC connection, 12 mm diameter, min. Conductivity 100 microsimsen.
Redox Prob: 7 bar/ 70 °C (3,5 bar-80 °C), Measuring range 0-1000 mV, epoxy body, BNC connection, 12 mm diameter.

Filtre Filter



Malzeme Cinsi Description	Kod Code	Fiyat (Adet) Price (Pcs)	Kg /Adet Kg/Pcs	Koli/Adet Box/Pcs
NFIL60 5" Filtre NFIL60 5" Filter	ATS HDS046	68,00 €	0,20	1

60 mikron,off-line. 5 bar 65C, 6x8,PP gövde

Seviye Sensörlü Prob Haznesi Prob Standpipe With Level Sensor



Malzeme Cinsi Description	Kod Code	Fiyat (Adet) Price (Pcs)	Kg /Adet Kg/Pcs	Koli/Adet Box/Pcs
NPED 4 Seviye Sensörlü Prob Haznesi NPED 4 Prob Standpipe With Level Sensor	ATS HDS047	226,00 €		1

PP gövde. 6x8 BNC bağlantılı seviye sensörü. 2 adet Ø12 Prob girişi. 50°C / 5 bar.off-line prob hazneli.

Prob Tutucu Prob Standpad



Malzeme Cinsi Description	Kod Code	Fiyat (Adet) Price (Pcs)	Kg /Adet Kg/Pcs	Koli/Adet Box/Pcs
PEA 1/2" Prob Tutucu PEA 1/2" Prob Standpad	ATS HDS048	17,00 €		1

Boruya monte tip,5 bar 65C.PVDF.line

YEDEK ÜRÜNLER SUBSTITUTE PRODUCTS

Kalibrasyon Sıvıları Calibration Liquids



Malzeme Cinsi Description	Kod Code	Fiyat (Adet) Price (Pcs)	Kg /Adet Kg/Pcs	Koli/Adet Box/Pcs
BSD 650 mV ,50 ml	ATS HDS049	18,50 €		1
BSA 4 ph ,50 ml	ATS HDS050	13,00 €		1
BSB 7 ph , 50 ml	ATS HDS051	13,00 €		1
BSC 9 ph ,50 ml	ATS HDS052	13,00 €		1

Çekvalfler Checkvalves



Malzeme Cinsi Description	Kod Code	Fiyat (Adet) Price (Pcs)	Kg /Adet Kg/Pcs	Koli/Adet Box/Pcs
1/2" Emiş Filtresi Çekvalf Suction filter Checkvalve	ATS HDS053	29,50 €		1
1/2" Basma Enjektörü Çekvalf Discharge Injection Nozzle Checkvalve:	ATS HDS054	30,00 €		1
3/8" Pompa Kafası Çekvalfi Pump Head Checkvalf	ATS HDS055	17,00 €		1

Seviye Sensörü Level Sensor



Malzeme Cinsi Description	Kod Code	Fiyat (Adet) Price (Pcs)	Kg /Adet Kg/Pcs	Koli/Adet Box/Pcs
Seviye Sensörü BNC Bağlantı (Yeni Tip) Level Sensor with BNC connection (New Type)	ATS HDS056	29,00 €		1
Seviye Sensörü BNC Bağlantı Level Sensor with BNC connection	ATS HDS057	29,00 €		1

PANELLİ OTOMATİK KONTROL CİHAZLARI
 AUTOMATIC CONTROL DEVICES

Otomatik Kontrol Sistemi 02 (pH & ORP)
 Automatic Control System

Malzeme Cinsi Description	Kod Code	Fiyat (Adet) Price (Pcs)	m ³	Kg /Adet Kg/Pcs	Koli/Adet Box/Pcs
Havuz Kontrol Sistemi 2E 10L/5Bar Pool Control System 2E 10L/5Bar	ATS ANT02-750E	1.460,00 €	0-1000	11,95	1
Havuz Kontrol Sistemi 2E 25L/5Bar Pool Control System 2E 25L/5Bar	ATS ANT02-1500E	1.880,00 €	0-2000	13,50	1

NOT: Sıvı seviye kontrollü modeller için sipariş esnasında 2 adet SIVI SEVİYE TAKIMI PP ilave ediniz.

- 60x90 panel üzerinde bağlantı elemanları monte edilmiş halde
- Poolsaver Tetra
- Pislik tutucu ön filtre
- Elektrot akış hücresi
- Giriş - çıkış rekorları (6x8 mm) ve numune alma vanası
- Kalibrasyon sıvıları ve kalibrasyon rafı
- pH ve ORP elektrodu

- Connection elements mounted on 60x90 panel
- Poolsaver Tetra
- Dirt holder pre - filter
- Electrode flow cell
- Entry-exit glands (6x8 mm) and sampling valve
- Calibration fluids and calibration rack
- pH and ORP electrode

Otomatik Kontrol Sistemi 03 (pH & ORP)
 Automatic Control System

Malzeme Cinsi Description	Kod Code	Fiyat (Adet) Price (Pcs)	m ³	Kg /Adet Kg/Pcs	Koli/Adet Box/Pcs
Havuz Kontrol Sistemi 3E 5L/5Bar Pool Control System 3E 5L/5 Bar	ATS ANT03-E	1.080,00 €	0-500	8,40	1

- 45x60 panel üzerinde bağlantı elemanları monte edilmiş halde
- Poolsaver Tetra
- 2 adet 5L/5B Nano A Dozaj Pompası
- Çift girişli elektrod haznesi
- Kalibrasyon sıvıları ve kalibrasyon rafı
- pH ve ORP elektrodu

- Connection elements mounted on 45x60 panel
- Poolsaver Tetra
- 2pcs 5L/5B Nano A Dosing Pump
- Double-entry electrode housing cell and connection
- Calibration fluids and calibration rack
- pH and ORP electrode

PANELLİ OTOMATİK KONTROL CİHAZLARI
 AUTOMATIC CONTROL DEVICES

Otomatik Kontrol Sistemi 05 (pH & ORP)
 Automatic Control System

Malzeme Cinsi Description	Kod Code	Fiyat (Adet) Price (Pcs)	m ³	Kg /Adet Kg/Pcs	Koli/Adet Box/Pcs
Havuz Kontrol Sistemi 5E 5L/10Bar Pool Control System 5E 5L/10 Bar	ATS ANT05-E	1.120,00 €	0-500	7,05	1

- 50x75 panel üzerinde bağlantı elemanları monte edilmiş halde
- Poolsaver Tetra
- 2 adet seviye sensör girişi, 1 adet akış şartel girişi
- 2 adet 5L/10B Optima A Dozaj Pompası
- Çift girişli elektrod haznesi
- Kalibrasyon sıvıları ve kalibrasyon rafı
- pH ve ORP elektrodu

- Connection elements mounted on 50x75 panel
- Poolsaver Tetra
- 2 pcs level sensor input, 1 pcs flow switch input
- 2 pcs 5L/10B Optima A Dosing Pump
- Double-entry electrode housing cell and connection parts
- Calibration fluids and calibration rack
- pH and ORP electrode

Otomatik Kontrol Cihazları Yedek Parçaları
 Automatic Control System Spare Part

ATS ANT-Y4

ATS ANT-Y3

ATS ANT-Y5

ATS ANT-Y6

ATS ANT-Y7

ATS ANT-Y2

Malzeme Cinsi Description	Kod Code	Fiyat (Adet) Price (Pcs)	Kg /Adet Kg/Pcs	Koli/Adet Box/Pcs
ELEKTROD PH 1M E	ATS ANT-Y1	107,00 €		1
ELEKTROD ORP 1M E	ATS ANT-Y2	116,00 €		1
DOZAJ POMPA BASMA TAKIMI 4x6 V	ATS ANT-Y3	16,50 €		1
DOZAJ POMPA EMİS TAKIMI 4X6 V	ATS ANT-Y4	22,00 €		1
DOZAJ POMPA KAFA TAKIMI 40V	ATS ANT-Y5	53,00 €		1
DOZAJ POMPA KAFA TAKIMI 50V	ATS ANT-Y6	53,00 €		1
DOZAJ POMPA KAFA TAKIMI 3V	ATS ANT-Y7	43,00 €		1

OZON JENERATÖRLERİ OZONE GENERATOR

Eko Setler Jeneratör Dahil (%20 Verim) Eco Set Including Generator (20% Efficiency)



Malzeme Cinsi Description	Kod Code	Fiyat (Adet) Price (Pcs)	Havuz Kapasitesi Pool Capacity	Koli/Adet Box/Pcs
DO01 1 g/h Ozon Jeneratörü +Eco Set DO01 1 g/h Ozone Generator +ECO SET	ATS OZECO001	1.420,00 €	1-10 m3	1
DO03 3 g/h Ozon Jeneratörü +Eco Set DO03 3 g/h Ozone Generator +ECO SET	ATS OZECO002	1.337,00 €	11-30 m3	1
DO05 5 g/h Ozon Jeneratörü +Eco Set DO05 5 g/h Ozone Generator +ECO SET	ATS OZECO003	1.540,00 €	31-50 m3	1
DO07 7 g/h Ozon Jeneratörü +Eco Set DO07 7 g/h Ozone Generator +ECO SET	ATS OZECO004	1.500,00 €	51-70 m3	1
DO10 10 g/h Ozon Jeneratörü +Eco Set DO10 10 g/h Ozone Generator +ECO SET	ATS OZECO005	1.660,00 €	71-100 m3	1
DO15 15 g/h Ozon Jeneratörü +Eco Set DO15 15 g/h Ozone Generator +ECO SET	ATS OZECO006	1.780,00 €	101-150 m3	1

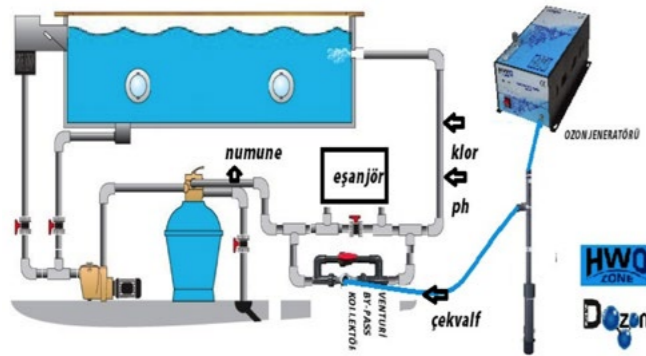

Esvel Havuzlar İçin Venturi By-Pass Montaj Şema
Venturi For Domestic Pools By-Pass Installation Diagram

Besi hattı üzerine kurulacak venturi by-pass kollektörü vasıtası ile gaz halindeki ozon suya karıştırılır. Bu yöntemde havuzdan kabarcık halinde ozon çıkışı gözlenecektir. Kabarcık çıkışı makine dairesine en yakın besi yada besilerden gözlemlenir. Eysel ve küçük havuzlarda tavsiye edilen bir yöntemdir. Ozon sistemi kullanımında sistemde 0,3-0,6 Ppm klor bulunmalıdır ve Ph 7,2-7,4 aralığında tutulmalıdır. Otomatik dozaj sistemi ile kullanılması tavsiye edilir.

Venturi by-pass collector to be installed on the feed line. Gaseous ozone is mixed with water by means of In this method, ozone in the form of bubbles from the pool output will be observed. The bubble outlet is the closest feeder to the engine room or observed in the diet. It is a recommended method in domestic and small pools. In the use of ozone system, 0,3-0,6 Ppm chlorine in the system and pH should be kept in the range of 7.2-7.4. It is recommended to use with automatic dosing system.

Mini Setler Jeneratör Dahil (%45 Verim) Mini Set Including Generator (45% Efficiency)



Malzeme Cinsi Description	Kod Code	Fiyat (Adet) Price (Pcs)	Havuz Kapasitesi Pool Capacity	Koli/Adet Box/Pcs
DO01 1 g/h Ozon Jeneratörü +Mini Set DO01 1 g/h Ozone Generator +MINI SET	ATS OZMINI001	1.860,00 €	1-10 m3	1
DO03 3 g/h Ozon Jeneratörü +Mini Set DO03 3 g/h Ozone Generator +MINI SET	ATS OZMINI002	1.657,00 €	11-30 m3	1
DO05 5 g/h Ozon Jeneratörü +Mini Set DO05 5 g/h Ozone Generator +MINI SET	ATS OZMINI003	2.010,00 €	31-50 m3	1
DO07 7 g/h Ozon Jeneratörü +Mini Set DO07 7 g/h Ozone Generator +MINI SET	ATS OZMINI004	1.821,00 €	51-70 m3	1
DO10 10 g/h Ozon Jeneratörü +Mini Set DO10 10 g/h Ozone Generator +MINI SET	ATS OZMINI005	2.130,00 €	71-100 m3	1
DO15 15 g/h Ozon Jeneratörü +Mini Set DO15 15 g/h Ozone Generator +MINI SET	ATS OZMINI006	2.250,00 €	101-150 m3	1

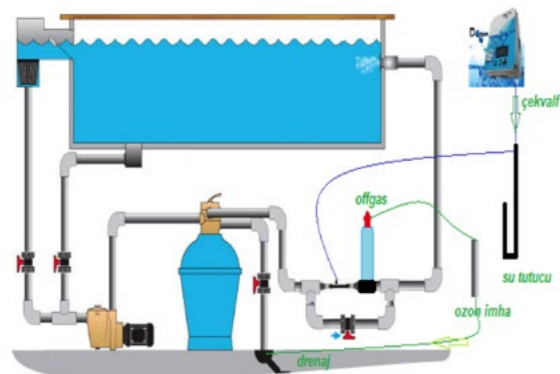

Dozon Mini Degazör Montaj Şeması
Dozon Mini Degastor Assembly Diagram

Besi hattı üzerine kurulacak venturi by-pass kollektörü vasıtası ile gaz halindeki ozon suya karıştırılır. Venturi sonrası konumlandırılan mini degazör sayesinde suya karışmayan fazla ozon gazı degazör üzerinden ventili marifeti ile tahliye edilerek imha modülüne alınır. Bu yöntemde havuzdan kabarcık halinde ozon çıkışı gözlenmez. Yoğun olmayan kullanıma sahip kapalı havuzlarda tavsiye edilen bir yöntemdir. Ozon sistemi kullanımında sistemde 0,3-0,6 Ppm klor bulunmalıdır ve Ph 7,2-7,4 aralığında tutulmalıdır. Otomatik dozaj sistemi ile kullanılması tavsiye edilir.

Gaseous ozone through the venturi by-pass collector to be installed on the feed line mixed with water. Thanks to the mini deaerator positioned after the venturi, the excess ozone that does not mix with the water. The gas is evacuated via the deaerator via the valve and taken to the destruction module. In this method, no ozone output is observed in the form of bubbles from the pool. It is a recommended method in indoor pools with non-intensive use. In the use of ozone system, 0,3-0,6 Ppm chlorine should be present in the system and the pH should be kept in the range of 7.2-7.4. It is recommended to use with automatic dosing system.

OZON JENERATÖRLERİ OZONE GENERATOR

Midi Setler Jeneratör Dahil (%65 Verim) Midi Set Including Generator (65% Efficiency)



Malzeme Cinsi Description	Kod Code	Fiyat (Adet) Price (Pcs)	Havuz Kapasitesi Pool Capacity	Koli/Adet Box/Pcs
DO01 1 g/h Ozon Jeneratörü +Midi Set DO01 1 g/h Ozone Generator +MIDI SET	ATS OZMIDI001	2.761,00 €	1-10 m3	1
DO03 3 g/h Ozon Jeneratörü +Midi Set DO03 3 g/h Ozone Generator +MIDI SET	ATS OZMIDI002	2.835,00 €	11-30 m3	1
DO05 5 g/h Ozon Jeneratörü +Midi Set DO05 5 g/h Ozone Generator +MIDI SET	ATS OZMIDI003	2.926,00 €	31-50 m3	1
DO07 7 g/h Ozon Jeneratörü +Midi Set DO07 7 g/h Ozone Generator +MIDI SET	ATS OZMIDI004	3.000,00 €	51-70 m3	1
DO10 10 g/h Ozon Jeneratörü +Midi Set DO10 10 g/h Ozone Generator +MIDI SET	ATS OZMIDI005	3.045,00 €	71-100 m3	1
DO15 15 g/h Ozon Jeneratörü +Midi Set DO15 15 g/h Ozone Generator +MIDI SET	ATS OZMIDI006	3.111,00 €	101-150 m3	1
DO20 10 g/h Ozon Jeneratörü +Midi Set DO20 10 g/h Ozone Generator +MIDI SET	ATS OZMIDI007	3.637,00 €	151-200 m3	1
DO25 25 g/h Ozon Jeneratörü +Midi Set DO25 25 g/h Ozone Generator +MIDI SET	ATS OZMIDI008	3.686,00 €	201-250 m3	1
DO30 30 g/h Ozon Jeneratörü +Midi Set DO30 30 g/h Ozone Generator +MIDI SET	ATS OZMIDI009	3.735,00 €	251-300 m3	1

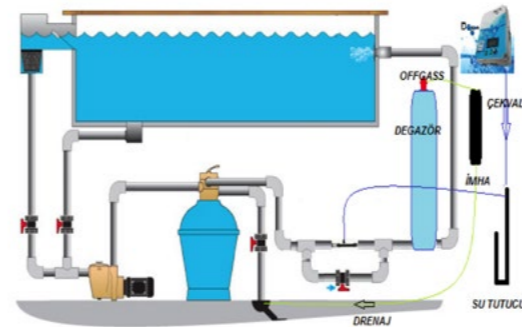

Dozon Midi Degazör Montaj Şeması
Dozon Midi Degasors Installation Diagram

Besi hattı üzerine kurulacak venturi by-pass kollektörü vasıtası ile gaz halindeki ozon suya karıştırılır. Venturi sonrası konumlandırılan degazör sayesinde suya karışmayan fazla ozon gazı degazör üzerinden ventili marifeti ile tahliye edilerek imha modülüne alınır. Bu yöntemde havuzdan kabarcık halinde ozon çıkışı gözlenmez. Yoğun kullanıma sahip kapalı havuzlarda tavsiye edilen bir yöntemdir. Ozon sistemi kullanımında sistemde 0,3-0,6 Ppm klor bulunmalıdır ve Ph 7,2-7,4 aralığında tutulmalıdır. Otomatik dozaj sistemi ile kullanılması tavsiye edilir.

By means of the venturi by-pass collector to be installed on the feed line, the gaseous ozone is mixed with water. Thanks to the deaerator positioned after the venturi, the excess ozone that does not mix with the water. The gas is taken to the destruction module by being evacuated via the deaerator via the valve. In this method, no ozone output is observed in the form of bubbles from the pool. It is a recommended method in indoor pools with intensive use. In the use of ozone system, 0,3-0,6 Ppm chlorine should be present in the system and the pH should be kept in the range of 7.2-7.4. It is recommended to use with automatic dosing system.

Maxi Setler Jeneratör Dahil (%80 Verim) Maxi Set Including Generator (80% Efficiency)



Malzeme Cinsi Description	Kod Code	Fiyat (Adet) Price (Pcs)	Havuz Kapasitesi Pool Capacity	Koli/Adet Box/Pcs
DO01 1 g/h Ozon Jeneratörü +Maxi Set DO01 1 g/h Ozone Generator +Maxi SET	ATS OZMAXI001	4.400,00 €	1-10 m3	1
DO03 3 g/h Ozon Jeneratörü +Maxi Set DO03 3 g/h Ozone Generator +Maxi SET	ATS OZMAXI002	4.477,00 €	11-30 m3	1
DO05 5 g/h Ozon Jeneratörü +Maxi Set DO05 5 g/h Ozone Generator +Maxi SET	ATS OZMAXI003	4.569,00 €	31-50 m3	1
DO07 7 g/h Ozon Jeneratörü +Maxi Set DO07 7 g/h Ozone Generator +Maxi SET	ATS OZMAXI004	4.641,00 €	51-70 m3	1
DO10 10 g/h Ozon Jeneratörü +Maxi Set DO10 10 g/h Ozone Generator +Maxi SET	ATS OZMAXI005	4.687,00 €	71-100 m3	1
DO15 15 g/h Ozon Jeneratörü +Maxi Set DO15 15 g/h Ozone Generator +Maxi SET	ATS OZMAXI006	4.753,00 €	101-150 m3	1
DO20 10 g/h Ozon Jeneratörü +Maxi Set DO20 10 g/h Ozone Generator +Maxi SET	ATS OZMAXI007	5.278,00 €	151-200 m3	1
DO25 25 g/h Ozon Jeneratörü +Maxi Set DO25 25 g/h Ozone Generator +Maxi SET	ATS OZMAXI008	5.328,00 €	201-250 m3	1
DO30 30 g/h Ozon Jeneratörü +Maxi Set DO30 30 g/h Ozone Generator +Maxi SET	ATS OZMAXI009	5.377,00 €	251-300 m3	1

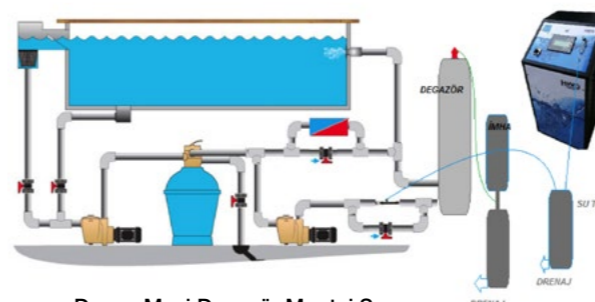

Dozon Maxi Degazör Montaj Şeması
Dozon Maxi Degastor Assembly Diagram

Besi hattı üzerine kurulacak venturi by-pass kollektörü vasıtası ile gaz halindeki ozon suya karıştırılır. Venturi sonrası konumlandırılan degazör sayesinde suya karışmayan fazla ozon gazı degazör üzerinden ventili marifeti ile tahliye edilerek imha modülüne alınır. Bu yöntemde havuzdan kabarcık halinde ozon çıkışı gözlenmez. Yoğun kullanıma sahip kapalı havuzlarda tavsiye edilen bir yöntemdir. Ozon sistemi kullanımında sistemde 0,3-0,6 Ppm klor bulunmalıdır ve Ph 7,2-7,4 aralığında tutulmalıdır. Otomatik dozaj sistemi ile kullanılması tavsiye edilir.

By means of the venturi by-pass collector to be installed on the feed line, the gaseous ozone is mixed with water. Thanks to the deaerator positioned after the venturi, the excess ozone that does not mix with the water. The gas is taken to the destruction module by being evacuated via the deaerator via the valve. In this method, no ozone output is observed in the form of bubbles from the pool. It is a recommended method in indoor pools with intensive use. In the use of ozone system, 0,3-0,6 Ppm chlorine should be present in the system and the pH should be kept in the range of 7.2-7.4. It is recommended to use with automatic dosing system.

BSPOOL TUZ KLOR JENERATÖRLERİ
 BSPOOL SALT CHLORINE GENERATORS

Özel Havuzlar – Analog Cihazlar N-BsSalt Serisi
 BS Salt For Private Pool- Analog Device

Malzeme Cinsi Description	Kod Code	Fiyat (Adet) Price (Pcs)	m ³	Kapasite Capacity	Koli/Adet Box/Pcs
N-BsSalt-15	ATS TK001	950,00 €	50-70	15 g/h	1
N-BsSalt-25	ATS TK002	1.250,00 €	100-125	25 g/h	1
N-BsSalt-35	ATS TK003	1.500,00 €	125-200	35 g/h	1

Özel Havuzlar – Dijital Cihazlar EvoBasic Serisi
 EvoBasic For Pool- Digital Device

Malzeme Cinsi Description	Kod Code	Fiyat (Adet) Price (Pcs)	m ³	Kapasite Capacity	Koli/Adet Box/Pcs
EvoBasic-15	ATS TK004	1.500,00 €	50-70	15 g/h	1
EvoBasic-25	ATS TK005	1.800,00 €	100-125	25 g/h	1
EvoBasic-35	ATS TK006	2.200,00 €	125-200	35 g/h	1

Özel Cihazlar
 EvoBasic Special Device

Malzeme Cinsi Description	Kod Code	Fiyat (Adet) Price (Pcs)	m ³	Kapasite Capacity	Koli/Adet Box/Pcs
EvoBasic-15MG	ATS TK007	1.700,00 €	50-70	15 g/h	1
EvoBasic-25MG	ATS TK008	2.080,00 €	100-125	25 g/h	1
EvoBasic-35MG	ATS TK009	2.450,00 €	125-200	35 g/h	1



Malzeme Cinsi Description	Kod Code	Fiyat (Adet) Price (Pcs)	m ³	Kapasite Capacity	Koli/Adet Box/Pcs
EvoTouch-15MG	ATS TK010	1.780,00 €	50-70	15 g/h	1
EvoTouch-25MG	ATS TK011	2.020,00 €	100-125	25 g/h	1
EvoTouch-35MG	ATS TK012	2.320,00 €	125-200	35 g/h	1



Malzeme Cinsi Description	Kod Code	Fiyat (Adet) Price (Pcs)	m ³	Kapasite Capacity	Koli/Adet Box/Pcs
EvoLink-15MG	ATS TK013	2.540,00 €	50-70	15 g/h	1
EvoLink-25MG	ATS TK014	2.780,00 €	100-125	25 g/h	1
EvoLink-35MG	ATS TK015	3.110,00 €	125-200	35 g/h	1

BSPOOL TUZ KLOR JENERATÖRLERİ
 BSPOOL SALT CHLORINE GENERATORS

Genel Havuzlar – Profesyonel Cihazlar Pro Serisi
 Pro Public Pool-Professional Device

Malzeme Cinsi Description	Kod Code	Fiyat (Adet) Price (Pcs)	m ³	Kapasite Capacity	Koli/Adet Box/Pcs
Pro 50	ATS TK016	3.360,00 €	200-250	50 g/h	1
Pro 70	ATS TK017	3.990,00 €	250-350	70 g/h	1
Pro 100	ATS TK018	6.160,00 €	400-500	100 g/h	1
Pro 150	ATS TK019	6.930,00 €	500-600	150 g/h	1



Malzeme Cinsi Description	Kod Code	Fiyat (Adet) Price (Pcs)	m ³	Kapasite Capacity	Koli/Adet Box/Pcs
Pro 200	ATS TK020	11.450,00 €	600-900	200 g/h	1



Malzeme Cinsi Description	Kod Code	Fiyat (Adet) Price (Pcs)	m ³	Kapasite Capacity	Koli/Adet Box/Pcs
Pro 250	ATS TK021	15.985,00 €	1000-1200	250 g/h	1
Pro 500	ATS TK022	29.855,00 €	2000-2500	500 g/h	1
Pro 750	ATS TK023	43.092,00 €	3000-3500	750 g/h	1
Pro 1000	ATS TK024	70.131,00 €	4000-5500	1000 g/h	1



ZODIAC Tuz Klorizasyon Otomasyonu / TRI® Modeller

ZODIAC Salt Chlorination Automation / TRI® Models



Malzeme Cinsi Description	Kod Code	Fiyat (Adet) Price (Pcs)	Su Hacmi	Klor Üretimi	Koli/Adet Box/Pcs
ZODIAC TRI® 18 Tuz Cihazı ZODIAC TRI® 18 Salt Chlorinator	ATS HDS063	1.984,00 €	70 m³	18 gr/s	1
ZODIAC TRI® 22 Tuz Cihazı ZODIAC TRI® 22 Salt Chlorinator	ATS HDS064	2.310,00 €	100 m³	22 gr/s	1
ZODIAC TRI® 35 Tuz Cihazı ZODIAC TRI® 35 Salt Chlorinator	ATS HDS065	2.860,00 €	170 m³	35 gr/s	1

OTONOM SİSTEMİ

AUTONOMOUS SYSTEM

- "Düşük" mod kapalı havuzlar için manuel veya otomatik olarak klor üretiminin azaltılması için
- "Güç" modu yoğun yüzme periyotları ve sağanak yağışlı hava koşulları için önceden önlem olarak TRI® pH ve TRI® PRO modüllü tüm TRI® modellerine takılabilir.
- To reduce manual or automatic chlorine production for "low" mode indoor pools
- The "Power" mode can be installed on all® TRI models with TRI pH and TRI® PRO modules as a precaution for heavy swimming periods and showery weather conditions.

ZODIAC Tuz Klorizasyon Otomasyonu / Ei® Modeller

ZODIAC Salt Chlorination Automation / Ei® Models



Hızlı Montaj
Batarya 10 dakikadan kısa sürede
yatay veya dikey olarak takılır.

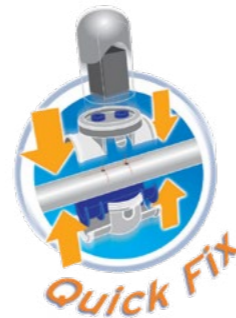

Malzeme Cinsi Description	Kod Code	Fiyat (Adet) Price (Pcs)	Su Hacmi	Klor Üretimi	Koli/Adet Box/Pcs
ZODIAC Ei® 10 Tuz Cihazı ZODIAC Ei® 10 Salt Chlorinator	ATS HDS066	1.416,00 €	40 m³	10 gr/s	1
ZODIAC Ei® 18 Tuz Cihazı ZODIAC Ei® 18 Salt Chlorinator	ATS HDS067	1.710,00 €	70 m³	17 gr/s	1
ZODIAC Ei® 25 Tuz Cihazı ZODIAC Ei® 25 Salt Chlorinator	ATS HDS068	1.985,00 €	110 m³	25 gr/s	1

Tuz Klorlama Otomasyon;

Basitleştirilmiş havuz bakımı, siz uzakta olduğunuz da bile kusursuz su kalitesi, kusursuz yüzme konforu.

Salt Chlorination Automation;

Simplified pool maintenance, perfect water quality even when you are away, perfect swimming comfort.

Kendi Kendini Temizleyen Birim

Ayarlanabilir polarite çevirici kullanan otomatik temizlenen elektrotlar.

Self-Cleaning Unit

Auto-cleaned electrodes using adjustable polarity converters.

ZODIAC TRI® pH Modülü

ZODIAC TRI® pH Modul



Malzeme Cinsi Description	Kod Code	Fiyat (Adet) Price (Pcs)	Koli/Adet Box/Pcs
ZODIAC TRI® pH Modülü ZODIAC TRI® pH Module	ATS HDS069	1.500,00 €	1

TRI® pH MODÜLÜ

TRI® pH MODULE

TRI®pH havuzunuzun pH seviyesini istenilen seviyede korur, herhangi bir müdahale olmadan...

- Filtreleme devresine takılı olan bir pH sensörünü kullanarak TRI®pH değerini ölçer ve sürekli olarak havuz suyunu denetler.
- Ölçülen değerlere bağlı olarak, pH minus (asit sıvı düzeltici) eklenerek havuzunuzun pH değerini hassas bir şekilde ayarlanmak üzere TRI®pH teknolojisi kullanılabilir.
- TRI®pH modülü sadece TRI® tuzlu su klorlayıcısı ile takılabilir.
- Güç; Kaynağı: 220-240 VAC (TRI® kutusuna bağlanır).
- Sağınimli pompa.
- Kalibrasyon: 1 nokta: pH 7.5
- Devirli dozaj. havuz ebadına ayarlanabilir.
- Maksimum sayaç; basıncı (enjeksiyon noktası): 1.5 bar.
- Ölçüm hassasiyeti: 0.1 pH
- Sensör tipi: birleşik.
- Yan-otomatik sensör kalibrasyonu: 1 nokta (pH 7.5)
- Özel aksesuarlar: sabitleme ve enjeksiyon kiti, pH sensörü. TRI®pH için 2 yıllık garanti

TRiPH®maintains the pH level of your pool at the desired level, without any interference...

- Measures TRiPH®value using a pH sensor installed in the filtration circuit and continuously controls pool water.
- Depending on the measured values, TRiPH®technology can be used to fine-tune the pH value of your pool by adding pH minus (acid liquid trimmer).
- TRiPH®modul can only be installed with TRI® salt water chlorinator.
- Power; Source: 220-240 VAC (connected to the TRI® box).
- Sağınimli pump.
- Calibration: 1 point: pH 7.5
- Cyclical dosage. pool size.
- Maximum counter; pressure (injection point): 1.5 bar.
- Measurement accuracy: 0.1 pH
- Sensor type: combined.
- Side-automatic sensor calibration: 1 point (pH 7.5)
- Special accessories: fastening and injection kits, pH sensor. 2-year warranty for TRiPH®

ZODIAC TRI® PRO Modülü

ZODIAC TRI® PRO Modülü



Malzeme Cinsi Description	Kod Code	Fiyat (Adet) Price (Pcs)	Koli/Adet Box/Pcs
ZODIAC TRI® PRO Modülü ZODIAC TRI® PRO Module	ATS HDS070	1.152,00 €	1

TRI® PRO MODÜLÜ

TRI® PRO MODÜLÜ

TRI®PRO havuzunuzun pH, Klor ve Redox seviyesini otomatik olarak istenilen seviyede korur, herhangi bir müdahale olmadan.

- Filtreleme devresine takılı olan bir kelepçe içinde pH sensörünü kullanarak TRI® PRO ,pH değerini ölçer ve sürekli olarak havuz suyunu denetler.
- Ölçülen değerlere bağlı olarak, pH minus (asit sıvı düzeltici) eklenerek havuzunuzun pH değerini hassas bir şekilde ayarlanmak üzere TRI®PRO teknolojisi kullanılabilir.
- Tesisata takılan kompleks kelepçe ile Ph,Klor ve redox ölçü ve dozaj düzenlemesini tek bir bağlantı ile yapan tek teknolojik cihazdır.
- TRI®PRO modülü sadece TRI® tuzlu su klorlayıcısı ile takılabilir. TRI®PRO için 2 yıllık garanti.

TRiPRO®automatically maintains the pH, Chlorine and Redox levels of your pool at the desired level, without any interference.

- Using the pH sensor in a clamp attached to the filtration circuit, TRi® PRO measures the pH value and continuously controls the pool water.
- Depending on the measured values, TRiPRO®technology can be used to fine-tune the pH value of your pool by adding pH minus (acid liquid editer).
- It is the only technological device that performs Ph, Chlorine and redox measurement and dosage arrangement with a single connection with the complete clamp attached to the installation.
- The TRiPRO®module can only be installed with the TRI® saltwater chlorinator. 2-year warranty for TRiPRO®.

Motorlu Karıştırıcı Kimyasal Bidonlu
 Motorized Mixer With Chemical Cans

Malzeme Cinsi Description	Kod Code	Fiyat (Adet) Price (Pcs)	Kapasite Capacity	Koli/Adet Box/Pcs
Motorlu Kimyasal Karıştırıcı Motorized Chemical Mixer	ATS HDS071	1.025,00 €	100 lt	1
Motorlu Kimyasal Karıştırıcı Motorized Chemical Mixer	ATS HDS072	1.100,00 €	200 lt	1

Bidon Karıştırıcısı (Manuel)
 Can Mixer (Manuel)

Malzeme Cinsi Description	Kod Code	Fiyat (Adet) Price (Pcs)	Kg /Adet Kg/Pcs	Koli/Adet Box/Pcs
Bidon Karıştırıcı Can Mixer	ATS HDS075	30,00 €	0,30	1

Kimyasal Tank
 Chemical Tank

Malzeme Cinsi Description	Kod Code	Fiyat (Adet) Price (Pcs)	Kapasite	Kg /Adet Kg/Pcs	Koli/Adet Box/Pcs
Kimyasal Bidon Chemical Mixing Tank	ATS HDS077	55,00 €	100 lt	5,00	1
Kimyasal Bidon Chemical Mixing Tank	ATS HDS078	95,00 €	200 lt	8,00	1

Klorinatör
 Chlorinator

Malzeme Cinsi Description	Kod Code	Fiyat (Adet) Price (Pcs)	Kg /Adet Kg/Pcs	Koli/Adet Box/Pcs
Klorinatör on-line 2 kg Kapasiteli Chlorinator on-line 2 kg Capacity	ATS HDS079	25,00 €	1,00	1
Klorinatör off-line 2 kg Kapasiteli Chlorinator off-line 2 kg Capacity	ATS HDS080	40,00 €	1,20	1
Klorinatör on-line 4 kg Kapasiteli Chlorinator on-line 4 kg Capacity	ATS HDS081	45,00 €	1,70	1
Klorinatör off-line 4 kg Kapasiteli Chlorinator off-line 4 kg Capacity	ATS HDS082	80,00 €	1,90	1

HAVUZ KİMYASALLARI

POOL CHEMICALS



SAĞLIK BAKANLIĞI ONAYLI HAVUZ KİMYASALLARI
 MINISTRY OF HEALTH APPROVED CHEMICALS

Klorlar
 Chlorine

Malzeme Cinsi Description	Kod Code	Fiyat (Adet) Price (Pcs)	Ambalaj Packaging	Koli/Adet Box/Pcs
% 56 Granül Klor Stabilizatörlü % 56 Granule Chlorine Stabilized	ATS HDS083	750,00 \$	50 kg	1
% 56 Granül Klor Stabilizatörlü % 56 Granule Chlorine Stabilized	ATS HDS084	180,00 \$	18 kg	1
% 56 Granül Klor Stabilizatörlü % 56 Granule Chlorine Stabilized	ATS HDS085	110,00 \$	10 kg	1
% 90 Granül Klor Stabilizatörlü % 90 Granule Chlorine Stabilized	ATS HDS086	850,00 \$	50 kg	1
% 90 Granül Klor Stabilizatörlü % 90 Granule Chlorine Stabilized	ATS HDS087	125,00 \$	10 kg	1
% 90 Tablet Klor Stabilizatörlü %90 Chlorine Tablets Stabilized	ATS HDS088	850,00 \$	50 kg	1
% 90 Tablet Klor Stabilizatörlü %90 Chlorine Tablets Stabilized	ATS HDS089	135,00 \$	10 kg	1
% 70 Granül Kalsiyum Hipoklorit %70 Granule Calcium Hypochlorite	ATS HDS090	1.000,00 \$	45 kg	1

PH Ayarlayıcılar
 PH Regulatory

Malzeme Cinsi Description	Kod Code	Fiyat (Adet) Price (Pcs)	Ambalaj Packaging	Koli/Adet Box/Pcs
PH (-) Granül PH Düşürücü PH (-) Granule PH Lowering	ATS HDS091	60,00 €	25 kg	1
PH (-) Granül PH Düşürücü PH (-) Granule PH Lowering	ATS HDS092	35,00 €	10 kg	1
PH (+) Granül PH Yükseltici PH (+) Granule PH Amplifier	ATS HDS093	38,00 €	10 kg	1

Yosun Önleyiciler
 Anti-Alga

Malzeme Cinsi Description	Kod Code	Fiyat (Adet) Price (Pcs)	Ambalaj Packaging	Koli/Adet Box/Pcs
Sıvı Yosun Önleyici Liquid Algaeist	ATS HDS094	55,00 €	20 lt	1
Sıvı Yosun Önleyici Liquid Algaeist	ATS HDS095	30,00 €	10 lt	1

Çökelticiler
 Sedimentary

Malzeme Cinsi Description	Kod Code	Fiyat (Adet) Price (Pcs)	Ambalaj Packaging	Koli/Adet Box/Pcs
Sıvı Çökeltici Liquid Flocculant	ATS HDS096	45,00 €	20 lt	1
Sıvı Çökeltici Liquid Flocculant	ATS HDS097	28,00 €	10 lt	1

Parlatıcılar
 Schoc

Malzeme Cinsi Description	Kod Code	Fiyat (Adet) Price (Pcs)	Ambalaj Packaging	Koli/Adet Box/Pcs
Parlatıcı Berraklaştırıcı Clarifier	ATS HDS098	50,00 €	20 lt	1
Parlatıcı Berraklaştırıcı Clarifier	ATS HDS099	30,00 €	10 lt	1

Yüzey Temizleyici
 Surface Cleaner

Malzeme Cinsi Description	Kod Code	Fiyat (Adet) Price (Pcs)	Ambalaj Packaging	Koli/Adet Box/Pcs
Havuz Yüzey Temizleyicisi Pool Surface Cleaner	ATS HDS100	120,00 €	25 lt	1
Havuz Yüzey Temizleyicisi Pool Surface Cleaner	ATS HDS101	45,00 €	10 lt	1

Ayak Dezenfektanı
 Footh Disinfectant

Malzeme Cinsi Description	Kod Code	Fiyat (Adet) Price (Pcs)	Ambalaj Packaging	Koli/Adet Box/Pcs
Ayak Dezenfektanı Foot Disinfectant	ATS HDS102	120,00 €	25 lt	1
Ayak Dezenfektanı Foot Disinfectant	ATS HDS103	75,00 €	10 lt	1

Kış Bakım İlacı
 Winter Care Chemical

Malzeme Cinsi Description	Kod Code	Fiyat (Adet) Price (Pcs)	Ambalaj Packaging	Koli/Adet Box/Pcs
Kış Bakım İlacı Winter Maintenance Chemical	ATS HDS104	220,00 €	25 lt	1
Kış Bakım İlacı Winter Maintenance Chemical	ATS HDS105	120,00 €	10 lt	1

Sıvı Klor-PH
 Liquid Chlor-PH

Malzeme Cinsi Description	Kod Code	Fiyat (Adet) Price (Pcs)	Ambalaj Packaging	Koli/Adet Box/Pcs
Sıvı Klor Liquid Chlor	ATS HDS106	50,00 €	25 lt	1
Sıvı PH Liquid Chlor	ATS HDS107	50,00 €	25 lt	1

Filtre Temizleyici
 Filter Cleaner

Malzeme Cinsi Description	Kod Code	Fiyat (Adet) Price (Pcs)	Ambalaj Packaging	Koli/Adet Box/Pcs
Toz Filtre Temizleyicisi Powder Filter Cleaner	ATS HDS108	75,00 €	5 lt	1
Toz Filtre Temizleyicisi Powder Filter Cleaner	ATS HDS109	35,00 €	1 lt	1

Filtre Temizleyici
 Test Kits In Liquid And Tablets

Malzeme Cinsi Description	Kod Code	Fiyat (Adet) Price (Pcs)	Ambalaj Packaging	Koli/Adet Box/Pcs
Sıvılı Test Kiti Test Kit in Liquid	ATS HDS110	13,00 €	1 Adet	1
Haplı Test Kiti Test Kit in Tablet	ATS HDS111	15,00 €	1 Adet	1
DPD1 Test Hapı - CL DPD1 Test Tablet - CL	ATS HDS112	4,00 €	1 Folyo	1
DPD3 Test Hapı - CL DPD3 Test Tablet - CL	ATS HDS113	4,00 €	1 Folyo	1
PHENOL RED Test Hapı - pH PHENOL RED Test Tablet - pH	ATS HDS114	4,00 €	1 Folyo	1
OTO Test Sıvısı - CL OTO Test Liquid - CL	ATS HDS115	4,50 €	1 Şişe	1
PHENOL RED Test Sıvısı - pH PHENOL RED Test Liquid - pH	ATS HDS116	4,50 €	1 Şişe	1

HAVUZ KİMYASALLARI KULLANIMI

POOL CHEMICAL USING DIRECTIONS

Ürün / Product	İşlevi / Function	Kullanım Miktarı / Usage Amount
% 56 Granül klor 56 % Granule Chlorine	Dezenfeksiyon İçin For Disinfection	100 m ³ Havuz suyuna 0,5 kg / gün (Umuma açık havuzlarda)
		100 m ³ Havuz suyuna 0,5 kg / haftada (Ev havuzlarında)
	Şoklamak İçin For shocking	100 m ³ Havuz suyuna 0,6 - 1 kg / 15 gün (Umuma açık havuzlarda)
		100 m ³ Havuz suyuna 0,6 1 kg / ay (Ev havuzlarında)
% 90 Granül klor % 90 Granule Chlorine	Dezenfeksiyon İçin For Disinfection	100 m ³ Havuz suyuna 0,35 kg / gün (Umuma açık havuzlarda)
		100 m ³ Havuz suyuna 0,35 kg / haftada (Ev havuzlarında)
% 90 Tablet klor % 90 Granule Chlorine	Dezenfeksiyon İçin For Disinfection	100 m ³ Havuz suyuna 1 Tablet / gün (10 - 12 günde bir)
% 70 Kalsiyum Hipoklorit	Dezenfeksiyon İçin For Disinfection	100 m ³ Havuz suyuna 0,2 kg / gün
PH (-) Toz	PH Düşürücü PH Booster	100 m ³ Havuz suyuna 1 kg pH değerini 0,1 derece düşürmek için
PH (+) Toz	PH Yükseltici PH Reducer	100 m ³ Havuz suyuna 1 kg pH değerini 0,1 derece yükseltmek için
PH (-) Sıvı	PH Düşürücü PH Booster	100 m ³ Havuz suyuna 1 lt pH değerini 0,1 derece düşürmek için
PH (+) Sıvı	PH Yükseltici PH Reducer	100 m ³ Havuz suyuna 1 lt pH değerini 0,1 derece yükseltmek için
Yosun Önleyici Moss Prohibition	Yosun Oluşmasını Önler Prohibits Moss Generation	100 m ³ Havuz suyuna 1,5 lt ilk doz. Müteakip doz 0,5 lt / hafta (Açık havuzlarda)
		100 m ³ Havuz suyuna 1,5 lt ilk doz. Müteakip doz 0,3 lt / haftada (Kapalı havuzlarda)
Çökeltici Precipitator	Topaklayıcı Flocculant	100 m ³ Havuz suyuna 0,03 - 0,2 lt / gün
Parlatıcı Polisher	Berraklaştırıcı Clarifier	100 m ³ Havuz suyuna 0,03 - 0,2 lt / gün
Ayak dezenfektanı Foot Disinfection	Mantar Öldürücü Dezenfektan Fungicide Disinfecting Agent	% 0,5 Sulandırılarak kullanılır
Yüzey Temizleyici Surface Cleaner	Yüzey Dezenfeksiyonu Surface Disinfection	% 1 Sulandırılarak kullanılır
Kış Bakımı Winter Maintenance	Kışın Yosunlaşma ve Donmaya Karşı Against Mossiness And Freezing In Winters	100 m ³ Havuz suyuna 3 - 5 lt (Suyun sertliğine bağlı olarak) 2 ayda bir tekrarlanır.

UYARILAR

WARNINGS

- Kimyasal ürünleri kullanırken, etiketi dikkatli okumalı ve talimatlara uyulmalıdır.
- Ürünler asla birbirine karıştırılmamalı, önce biri sonra da diğerleri tek tek havuza atılmalıdır.
- Kimyasal ürünler kullanırken eldiven kullanılmalı, göze temas etmesi halinde bol su ile yıkanmalı, doktora müracaat edilmelidir.
- Kimyasal ürünler çocukların ulaşamayacağı bir yerde kuru, kapalı ve havadar bir mekanda tutulmalı, ateşle yaklaşılmamalıdır.
- While using chemical materials the labels shall be read carefully and instructions shall be followed
- The products shall never be mixed with each other, firstly one of them shall be thrown to the pool and then the other one.
- Gloves shall be used while chemical products are used, if there occurs eye contact eyes shall be washed with lots of water and immediately the person whose eye has contacted with these chemicals shall go to doctor for control.
- Chemical products shall be kept out of reach of children in a place which is dry, closed and airy and do not get closer to these chemicals with fire.

Problem ve Çözümleri (100 m³ için)

Problem ve Çözümleri (100 m³ için)

PROBLEM	SEBEP	ÇÖZÜM
Bulanık Su	1) pH yüksek 2) Aşırı çözünmüş katılar 3) Kötü filtreleme 4) Aşırı organik çökeltiler	1) pH 7,2 - 7,6 arasında ayarlayın 2) Havuz suyunun bir kısmını taze su ile değiştirin 3) Ters yıkama ile filtreyi temizleyin. Sıvı çöktürücü ile 100 m ³ e 2 lt çöktürücü dökerek çöktürme işlemi yapın (şok uygu-lama) 4) % 90'lık granül klor ile şoklayın
Yeşil Su	Yosun oluşumu	% 90'lık granül klor ile şok klorlama uygulayın. Yüzeyleri fırçalayıp süpürme işleminden sonra 100 m ³ havuza 2,5 lt yosun önleyici ilave edin.
Kahverengi Su	Demir yada manganez varlığı	Şok klorlama yapın ve 100 m ³ e lt çöktürücü ilave edin
Göz Ve Deri Tahrişi Kötü Kokular	1) pH ayarsız 2) Birleşik klor fazla	1) pH kontrol edin 7,2 - 7,6 arasında ayarlayın 2) 100 m ³ e 1 kg % 90'lık klor ilave ederek şoklama yapın. 3) 2 gün havuzu kullanmayınız

SEZON BAŞINDA YÜZME HAVUZUNU DEVREYE ALMAK

PUTTING INTO USE OF THE POOL IN THE BEGINNING OF THE SEASON

Sezon süresince oluşacak problemleri engellemek için aşağıdaki işlemler takip edilmelidir.

- Tüm ekipmanlar gözden geçirilmeli; gerekirse servis çağrılmalıdır.
- Gerekli görülürse havuz boşaltılarak, dibini ve yan duvarlarını sulandırılmış yosun çözücü ile temizleyin.
- Havuz boşsa suyla doldurun, doluyorsa filtrasyon sistemini çalıştırın.
- 100 m³ suyu 2 lt çökeltici ile çöktürme işlemi yapın.
Çökeltici suya ilave edildikten 3 - 4 saat sonra filtrasyon işlemi durdurun.
Bir gece bekledikten sonra süpürme işlemi yapın.
- Filtrasyon sistemini tekrar çalıştırın.
- Ph ve alkalinite değerlerini ideal değerlere getirin.
- Tüm ölçüm değerlerini tekrar ölçün (ph), Alkalinite, Klor, Bileşik klor, sertlik.
- %90'lık granül klor ile havuzu şoklayın.
Havuzu devreye aldıktan ve kontroller tamamlandıktan sonra rutin uygulamaya geçin.

The processes below shall be followed in order to prohibit the problems that can be occurred during season.

- All the equipments shall be reviewed; if necessary the service shall be called.
- If it is necessary, the pool shall be emptied and then bottom of the pool and the side walls of the pool shall be cleaned with watered moss solvent.
- If the pool is empty, fill it up with water, if it is already filled up with water then make the filtration sytem work.
- Perform the precipitation process by using 2 litres precipitator for 100 m³ water. 3-4 hours after the precipitator is added to the water stop the filtration process. Perform the sweeping process after one night passes.
- Restart the filtration system.
- Bring the pH and alkaline values to ideal values.
- Evaluate all the measurement values again (ph). Alkaline, chlorine, combined chlorine, solidity.
- Perform shocking process with chlorine which has 90 % ratio.

Start to routine implementation after the pool is put into use and the controls are completed.

Not / Note

DİĞER ÜRÜNLER OTHER PRODUCTS



DİĞER ÜRÜNLER
OTHER PRODUCTS

YERLİ & İTHAL ELEKTRİKLİ ISITICILAR
ELECTRICAL EXCHANGERS

Yerli Elektrikli Isıtıcı
Three-phase Electrical Exchanger



Malzeme Cinsi Description	Kod Code	Fiyat (Adet) Price (Pcs)	Koli/Adet Box/Pcs
9 kW Trifaze Elektrikli Isıtıcı 9 Kw Electric Heater Three-Phase	ATS IST001	500,00 €	1
12 kW Trifaze Elektrikli Isıtıcı 12 Kw Electric Heater Three-Phase	ATS IST002	550,00 €	1
15 kW Trifaze Elektrikli Isıtıcı 15 Kw Electric Heater Three-Phase	ATS IST003	600,00 €	1
18 kW Trifaze Elektrikli Isıtıcı 18 Kw Electric Heater Three-Phase	ATS IST004	625,00 €	1
21 kW Trifaze Elektrikli Isıtıcı 21 Kw Electric Heater Three-Phase	ATS IST005	650,00 €	1
24 kW Trifaze Elektrikli Isıtıcı 24 Kw Electric Heater Three-Phase	ATS IST006	750,00 €	1

Pahlen Elektrikli Isıtıcılar
Pahlen Electrical Exchanger



Malzeme Cinsi Description	Kod Code	Fiyat (Adet) Price (Pcs)	Koli/Adet Box/Pcs
3 Kw Trifaze Elektrikli Isıtıcı 3 Kw Electric Heater Three-Phase	ATS IST007	752,00 €	1
6 Kw Trifaze Elektrikli Isıtıcı 6 Kw Electric Heater Three-Phase	ATS IST008	768,00 €	1
9 Kw Trifaze Elektrikli Isıtıcı 9 Kw Electric Heater Three-Phase	ATS IST009	790,00 €	1
12 Kw Trifaze Elektrikli Isıtıcı 12 Kw Electric Heater Three-Phase	ATS IST010	823,00 €	1
15 Kw Trifaze Elektrikli Isıtıcı 15 Kw Electric Heater Three-Phase	ATS IST011	845,00 €	1
18 Kw Trifaze Elektrikli Isıtıcı 18 Kw Electric Heater Three-Phase	ATS IST012	857,00 €	1

- Plastik gövdeli elektrikli ısıtıcı
- INCOLOY 825 özel alışım ısı elemanı
- 0-45 °C Termostatlı, 60 °C limit kontrollü
- Akış şalterli
- Minimum Debi 90 lt. / dk.
- 100 m3' e kadar olan havuzlar içindir
- Maximum basınç 2,5 Bar
- Yatay kurulum, bağlantı çapı 50 mm
- Tuzlu suya uygundur (Tuzlu su için iletişime geçiniz).
- Electric heater with plastic body
- INCOLOY 825 special reception heat element
- 0-45 °C Thermostat, 60 °C limit controlled
- Flow switch
- Minimum Debi 90 lt. / dk.
- For pools up to 100 m3
- Maximum pressure 2,5 Bar
- Horizontal installation, connection diameter 50 mm
- Not suitable for salt water (Please contact for salt water).

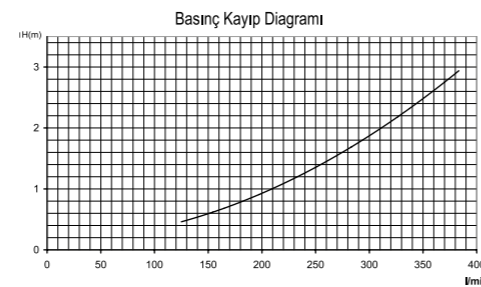
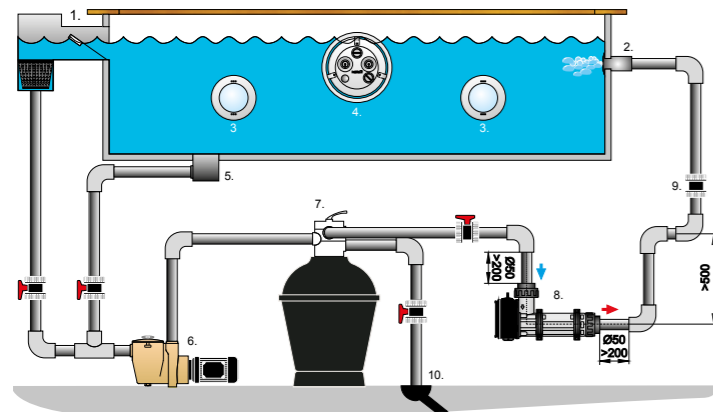

YERLİ & İTHAL ELEKTRİKLİ ISITICILAR
ELECTRICAL EXCHANGERS

Pahlen Elektrikli Isıtıcılar
Pahlen Electrical Exchanger



Malzeme Cinsi Description	Kod Code	Fiyat (Adet) Price (Pcs)	Koli/Adet Box/Pcs
3 Kw Trifaze Elektrikli Isıtıcı 3 Kw Electric Heater Three-Phase	ATS IST013	1.579,00€	1
6 Kw Trifaze Elektrikli Isıtıcı 6 Kw Electric Heater Three-Phase	ATS IST014	1.602,00 €	1
9 Kw Trifaze Elektrikli Isıtıcı 9 Kw Electric Heater Three-Phase	ATS IST015	1.625,00 €	1
12 Kw Trifaze Elektrikli Isıtıcı 12 Kw Electric Heater Three-Phase	ATS IST016	1.683,00 €	1
15 Kw Trifaze Elektrikli Isıtıcı 15 Kw Electric Heater Three-Phase	ATS IST017	1.704,00 €	1

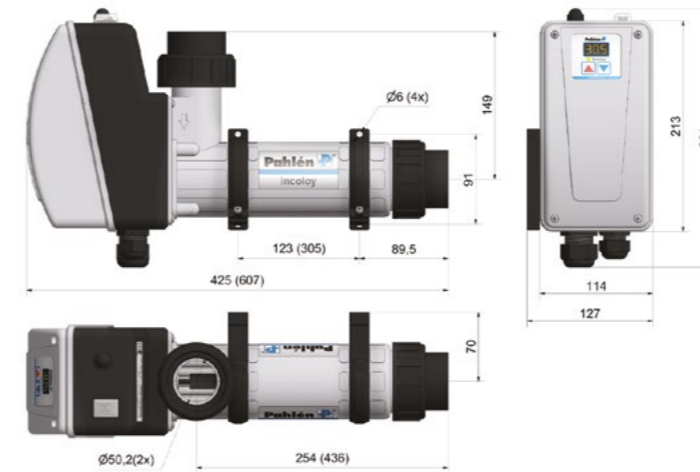

- Plastik gövdeli elektrikli ısıtıcı
- Dijital Ekran
- INCOLOY 825 özel alışım ısı elemanı
- 0-45 °C Termostatlı, 60 °C limit kontrollü
- Akış şalterli
- Minimum Debi 90 lt. / dk.
- 100 m3' e kadar olan havuzlar içindir
- Maximum basınç 2,5 Bar
- Yatay kurulum, bağlantı çapı 50 mm
- Tuzlu suya uygundur (Tuzlu su için iletişime geçiniz).
- Electric heater with plastic body
- Digital Display
- INCOLOY 825 special reception heat element
- 0-45 °C Thermostat, 60 °C limit controlled
- Flow switch
- Minimum Debi 90 lt. / dk.
- For pools up to 100 m3
- Maximum pressure 2,5 Bar
- Horizontal installation, connection diameter 50 mm
- Not suitable for salt water (Please contact for salt water).

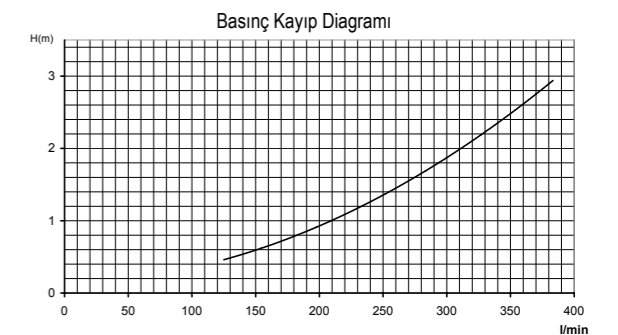
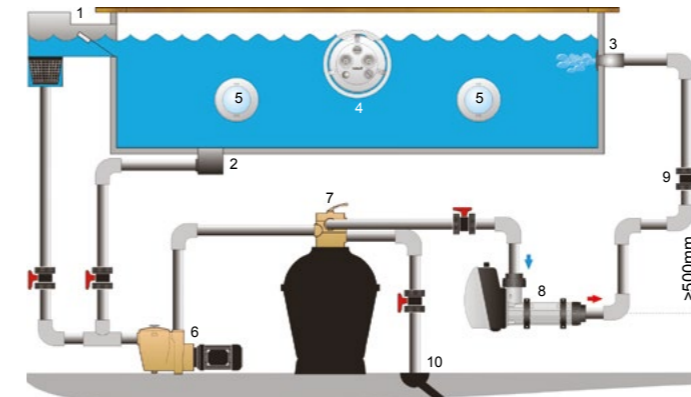

AVRUPA ISI POMPALARI
EUROPEAN HEAT PUMPS



Malzeme Cinsi Description	Kod Code	Fiyat (Adet) Price (Pcs)	Havuz m³	Kw	Kw
ISI POMPASI Z200 M2 POWER Z200 M2 POWER HEAT PUMP	ATS HDU001	2.636,00 €	0-30 m³	6,00	
ISI POMPASI Z200 M3 POWER Z200 M3 POWER HEAT PUMP	ATS HDU002	3.100,00 €	25-45 m³	9,00	Isıtma
ISI POMPASI Z200 M4 POWER Z200 M4 POWER HEAT PUMP	ATS HDU003	3.918,00 €	30-60 m³	12,0	
ISI POMPASI Z200 M5 POWER Z200 M5 POWER HEAT PUMP	ATS HDU004	4.765,00 €	40-70 m³	14,0	
ISI POMPASI Z300 M4 POWER FIRST Z300 M4 POWER FIRST HEAT PUMP	ATS HDU005	4.288,00 €	30-50 m³	9,0	Isıtma
ISI POMPASI Z300 M5 POWER FIRST Z300 M5 POWER FIRST HEAT PUMP	ATS HDU006	5.447,00 €	40-75 m³	13,0	
ISI POMPASI Z300 T5 POWER FIRST Z300 T5 POWER FIRST HEAT PUMP	ATS HDU007	5.447,00 €	40-75 m³	13,0	
ISI POMPASI Z300 M7 POWER FIRST Z300 M7 POWER FIRST HEAT PUMP	ATS HDU008	5.787,00 €	60-90 m³	16,0	
ISI POMPASI Z300 MD5 POWER FIRST Z300 MD5 POWER FIRST HEAT PUMP	ATS HDU009	5.787,00 €	40-75 m³	14,0	Isıtma ve Soğutma
ISI POMPASI Z300 TD5 POWER FIRST Z300 TD5 POWER FIRST HEAT PUMP	ATS HDU010	6.945,00 €	40-75 m³	14,0	
ISI POMPASI Z300 MD8 POWER FIRST Z300 MD8 POWER FIRST HEAT PUMP	ATS HDU011	8.172,00 €	60-110 m³	21,0	
ISI POMPASI Z300 TD8 POWER FIRST Z300 TD8 POWER FIRST HEAT PUMP	ATS HDU012	8.172,00 €	60-110 m³	21,0	
ISI POMPASI ZS500 MD4 ZS500 MD4 HEAT PUMP	ATS HDU107	6.128,00 €	30-60 m³	12,0	Isıtma ve Soğutma
ISI POMPASI ZS500 MD5 ZS500 MD5 HEAT PUMP	ATS HDU108	7.287,00 €	40-80 m³	15,0	
ISI POMPASI ZS500 MD8 ZS500 MD8 HEAT PUMP	ATS HDU109	8.558,00 €	80-110 m³	20,0	
ISI POMPASI POWER FORCE 25 POWER FORCE 25 HEAT PUMP	ATS HDU110	14.025,00 €	100-160 m³	33,0	Isıtma ve Soğutma
ISI POMPASI POWER FORCE 35 POWER FORCE 35 HEAT PUMP	ATS HDU111	18.707,00 €	140-200 m³	45,0	

Günümüzde ısı pompaları Mayıs ayından Eylül'e (veya bölgeye bağlı olarak Nisandan Ekim'e) kadar 0-200 m³ özel açık ya da kapalı havuzların verimli bir şekilde ısıtılmasının en ekonomik yoludur.

Today, heat pumps are 0-200 m³ from May to September (or April to October, depending on the region) it is the most economical way to heat private indoor or outdoor pools efficiently.

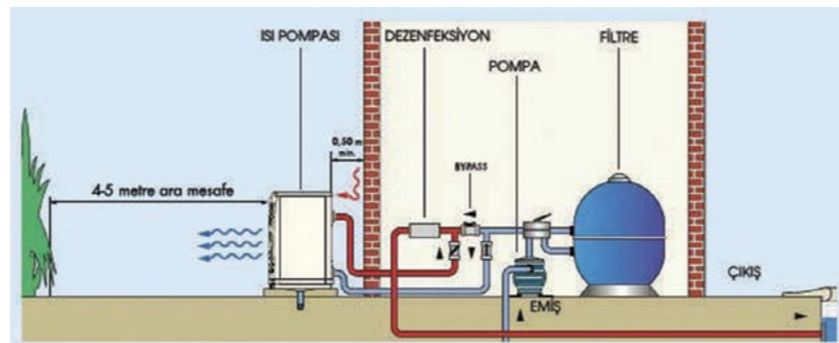

Su Perdesi Lux
Waterfall Curtain Lux

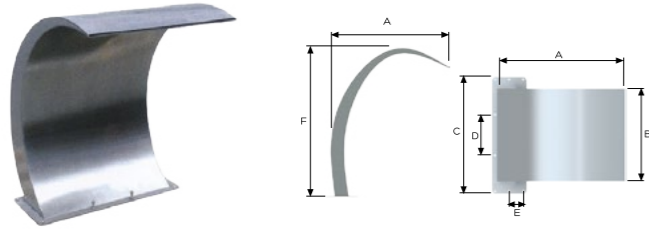

Ölçü Size	Kod Code	Fiyat (Adet) Price (Pcs)	Kg /Adet Kg/Pcs	Koli/Adet Box/Pcs	A (mm)	B (mm)	C (mm)	D (mm)	E (mm)	F (mm)	Bağlantı Connection	Pompa Gücü Pump Power
1000x400	ATS HDU067	1.000,00 €	29,00	1	755	400	620	155	8	1000	2"	1,1 kW
1000x500	ATS HDU068	1.100,00 €	34,00	1	755	500	680	170	8	1000	2"	1,5 kW
1000x600	ATS HDU069	1.150,00 €	40,00	1	755	600	760	190	8	1000	2"	2,2 kW

Su Perdesi Kuğu
Waterfall Curtain Swan

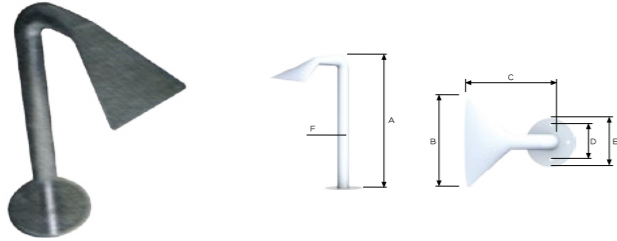

Ölçü Size	Kod Code	Fiyat (Adet) Price (Pcs)	Kg /Adet Kg/Pcs	Koli/Adet Box/Pcs	A (mm)	B (mm)	C (mm)	D (mm)	E (mm)	F (mm)	Bağlantı Connection	Pompa Gücü Pump Power
1000x400	ATS HDU070	600,00 €	13,00	1	1000	400	555	140	185	90	Ø63	1,1 kW
1000x600	ATS HDU071	680,00 €	15,00	1	1000	600	555	140	185	90	Ø63	2,2 kW

Su Perdesi Standart
Waterfall Curtain Standart

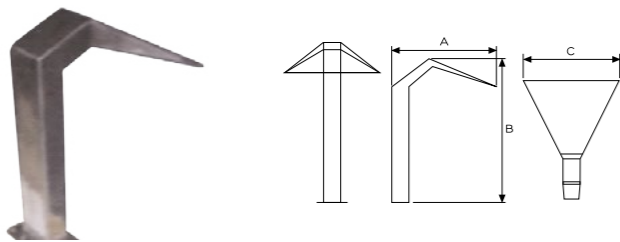

Ölçü Size	Kod Code	Fiyat (Adet) Price (Pcs)	Kg /Adet Kg/Pcs	Koli/Adet Box/Pcs	A (mm)	B (mm)	C (mm)	Bağlantı Connection	Pompa Gücü Pump Power
1000x400	ATS HDU072	1.150,00 €	13,00	1	755	1000	400	Ø63	1,1 kW
1000x500	ATS HDU073	1.250,00 €	15,00	1	755	1000	500	Ø63	1,5 kW
1000x600	ATS HDU074	1.300,00 €		1	755	1000	600	Ø63	2,2 kW

Su Perdesi Kobra
Waterfall Curtain Cobra

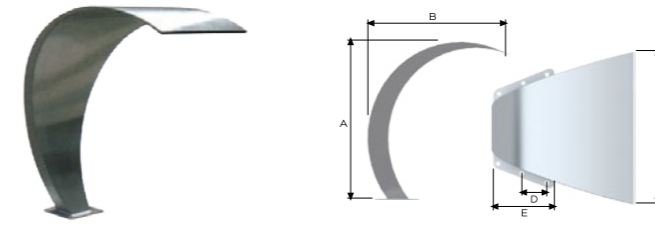

Ölçü Size	Kod Code	Fiyat (Adet) Price (Pcs)	Kg /Adet Kg/Pcs	Koli/Adet Box/Pcs	A (mm)	B (mm)	C (mm)	D (mm)	E (mm)	Bağlantı Connection	Pompa Gücü Pump Power
350x350	ATS HDU075	500,00 €	9,00	1	350	400	350	82	180	1 1/2"	1,1 kW
800x400	ATS HDU076	850,00 €	20,00	1	800	680	400	110	220	2"	1,5 kW
900x600	ATS HDU077	1.100,00 €	27,00	1	900	680	600	115	245	2"	2,2 kW

Su Perdesi Duvar Tipi
Waterfall Curtain Wall Type

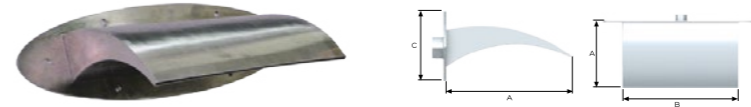

Ölçü Size	Kod Code	Fiyat (Adet) Price (Pcs)	Kg /Adet Kg/Pcs	Koli/Adet Box/Pcs	A (mm)	B (mm)	C (mm)	Bağlantı Connection	Pompa Gücü Pump Power
137x300	ATS HDU078	350,00 €	7,00	1	225	300	137	1 1/2"	1,1 kW
137x500	ATS HDU079	400,00 €	9,00	1	225	500	137	1 1/2"	1,5 kW

Duvar İçi Şelale
Waterfall In-Wall

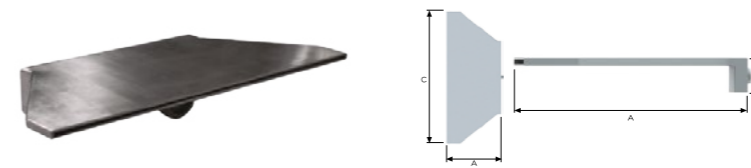

Ölçü Size	Kod Code	Fiyat (Adet) Price (Pcs)	Kg /Adet Kg/Pcs	Koli/Adet Box/Pcs	A (mm)	B (mm)	C (mm)	Bağlantı Connection	Pompa Gücü Pump Power
65 x 500	ATS HDU080	600,00 €	4,935	1	225	65	500	1 1/2" Dişli	1,5 kW

DALGIÇ POMPALAR
SUBMERCIBLE PUMPS

İthal Dalgıç Pompalar
Submercible Pumps



Malzeme Cinsi Description	Kod Code	Fiyat (Adet) Price (Pcs)	Kg /Adet Kg/Pcs	Koli/Adet Box/Pcs	Debi (m³/h) Flow (m³/h)
660 Plastik Temiz Su Dalgıç Pompa 400 W 660 Plastic Submersible Pump For Fresh Water	ATS HDU081	180,00 €		1	7 m³/h - 8 mSS
662 Plastik Kirli Su Dalgıç Pompa 900 W 662 Plastic Submersible Pump For Polluted Water	ATS HDU082	230,00 €		1	14 m³/h - 8 mSS
670 Paslanmaz Temiz Su Dalgıç Pompa 550 W 670 SS Submersible Pump For Fresh Water	ATS HDU083	250,00 €		1	10 m³/h - 8 mSS
676 Paslanmaz Kirli Su Dalgıç Pompa 110 W 676 SS Submersible Pump For Polluted Water	ATS HDU085	260,00 €		1	13,5 m³/h - 8 mSS

Not / Note

TEXPOOL HAVUZ LİNER

TEXPOOL POOL LINER

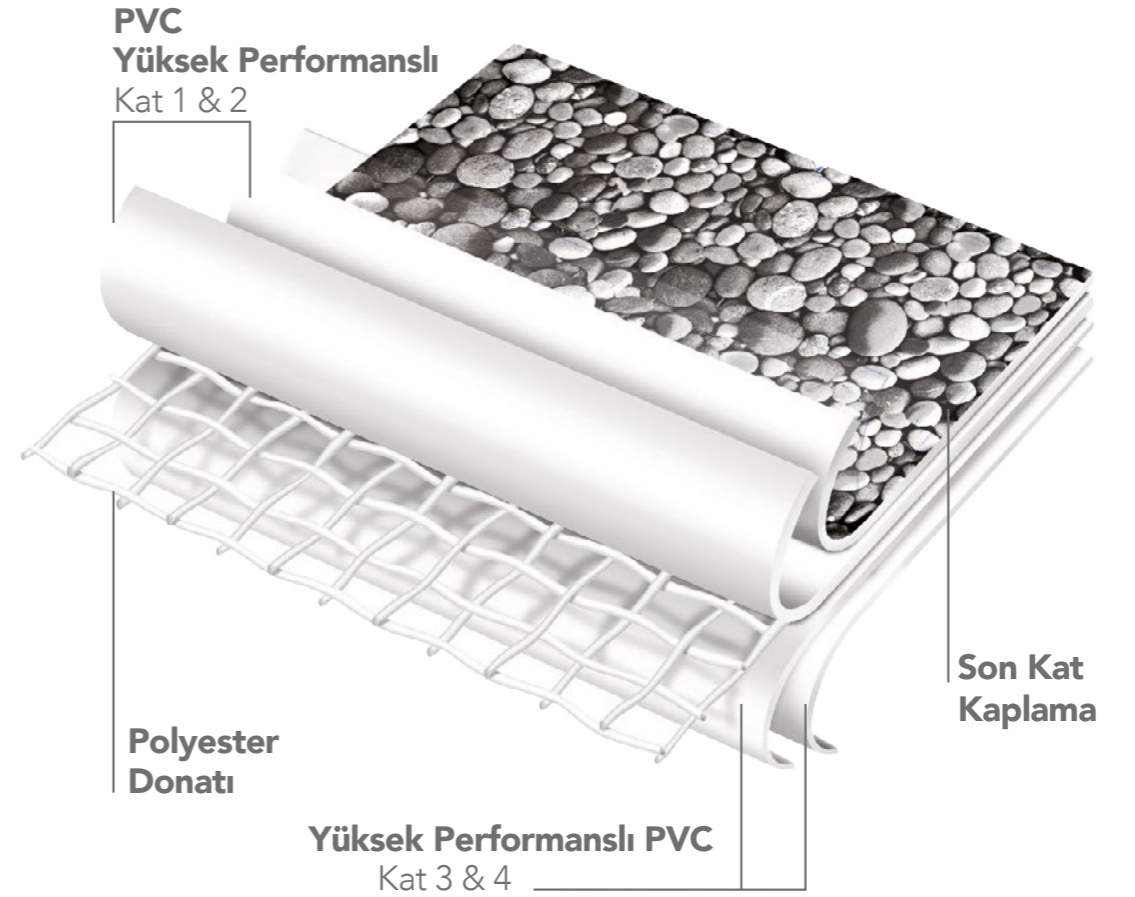

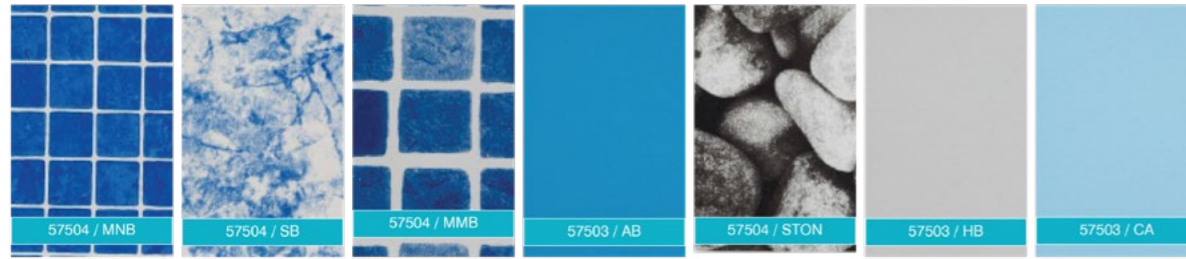
HAVUZ LINERLERİ
POOL LINER
Liners Glossy

Malzeme Cinsi Description	Kod Code	Fiyat (Adet) Price (Pcs)	Koli/Adet Box/Pcs	Kalınlık
57504 MNB Desenli Liner - Parlak 57504 MNB Design Liner - Shiny	ATS HLK001	26,00 €	1	1,5 mm
57504 SB Desenli Liner - Parlak 57504 SB Design Liner-Shiny	ATS HLK002	26,00 €	1	1,5 mm
57504 MMB Desenli Liner - Parlak 57504 MMB Design Liner-Shiny	ATS HLK003	26,00 €	1	1,5 mm
57503 AB Tek Renkli Liner - Parlak 57503 AB Unicolor Liner-Shiny	ATS HLK004	21,00 €	1	1,5 mm
57504 STON Desenli Liner - Parlak 57504 AB Stone Design Liner-Shiny	ATS HLK005	26,00 €	1	1,5 mm
57503 HB Tek Renkli Liner - Parlak 57503 HB Unicolor Liner-Shiny	ATS HLK006	21,00 €	1	1,5 mm
57503 CA Tek Renkli Liner - Parlak 57503 CA Unicolor Liner-Shiny	ATS HLK007	21,00 €	1	1,5 mm

Tüm Linerlar 40 m² ve katları olarak satılmaktadır. (Liner 1,60 mt eninde ve 25 mt boyundadır.)

Liners Unicolor

Malzeme Cinsi Description	Kod Code	Fiyat (Adet) Price (Pcs)	Koli/Adet Box/Pcs	Kalınlık
53594 AB Tek Renkli Liner - Mat 53594 AB Unicolor Liner - Matt	ATS HLK008	18,00 €	1	1,5 mm
53594 CA Tek Renkli Liner - Mat 53594 CA Unicolor Liner - Matt	ATS HLK009	18,00 €	1	1,5 mm
53594 DB Tek Renkli Liner - Mat 53594 DB Unicolor Liner - Matt	ATS HLK010	18,00 €	1	1,5 mm
53594 GB Tek Renkli Liner - Mat 53594 GB Unicolor Liner - Matt	ATS HLK011	18,00 €	1	1,5 mm
53594 GC Tek Renkli Liner - Mat 53594 GC Unicolor Liner - Matt	ATS HLK012	18,00 €	1	1,5 mm
53594 NB Tek Renkli Liner - Mat 53594 NB Unicolor Liner - Matt	ATS HLK013	18,00 €	1	1,5 mm
53594 HB Tek Renkli Liner - Mat 53594 HB Unicolor Liner - Matt	ATS HLK014	18,00 €	1	1,5 mm

Tüm Linerlar 40 m² ve katları olarak satılmaktadır. (Liner 1,60 mt eninde ve 25 mt boyundadır.)

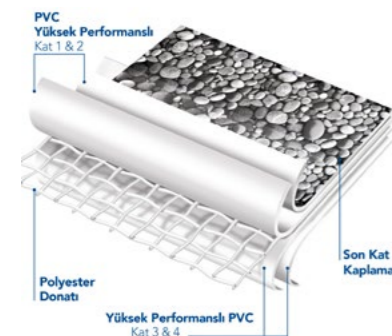
TEXPOOL - FLAG

Dört PVC katmandan oluşan polyester donatılı ile güçlendirilmiş sentetik (PVC_P) havuz membrandır. TEXPOOL, her türlü betonarme, çelik prefabrik yüzeylerde, yeni veya mevcut yüzme havuzlarında kullanılır.

ÖZELLİKLER

Mikroorganizmalara karşı yüksek direnç : « BIO-SHIELD »
 UV ışınlarına karşı yüksek direnç
 Yüksek delinme direnci
 Mükemmel kaynak kabiliyeti
 Sıcak-soğuk döngülerinden etkilenmez
 Yüzme havuzlarında su temizliği için kullanılan kimyasal ürünlere karşı dirençli
 EN 15836-2:2010 / ISO 9001 VE ISO 14001 Standartlarına göre üretilmiştir.

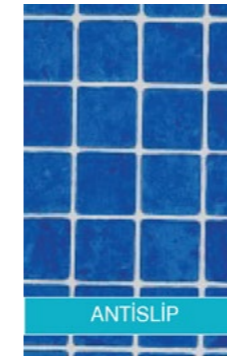

HAVUZ LINERLERİ
POOL LINER
Liners Glossy

Liners Unicolor

Malzeme Cinsi Description	Kod Code	Fiyat (Adet) Price (Pcs)	Koli/Adet Box/Pcs	Kalınlık
Antisliip - Parlak Antisliip - Shiny	ATS HLK015	25,00 €	1	1,5 mm

Tüm Linerlar 15 m² ve katları olarak satılmaktadır. (Liner 1,50 mt eninde ve 10 mt boyundadır.)

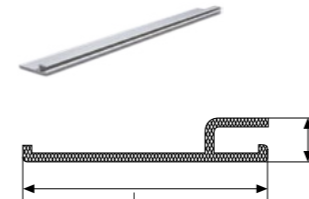
Malzeme Cinsi Description	Kod Code	Fiyat (Adet) Price (Pcs)	Koli/Adet Box/Pcs	Kalınlık
Antisliip - Mat Antisliip - Matt	ATS HLK016	23,00 €	1	1,5 mm

Tüm Linerlar 15 m² ve katları olarak satılmaktadır. (Liner 1,50 mt eninde ve 10 mt boyundadır.)

LINERS KENAR PROFİLLERİ
LINER CORNER PROFILE
Liner Kenar Profili
Liner Corner Profile

Malzeme Cinsi Description	Kod Code	Fiyat (Adet) Price (Pcs)	Koli/Mt Box/Mt
Liner Kenar Profili - 2,5 mt Liner Corner Profile-2,5 mt	ATS HDU086	2,00 €	125 mm

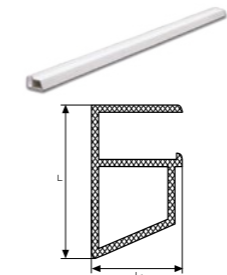
Liner Alın Profili
Liner Lock Profile

Malzeme Cinsi Description	Kod Code	Fiyat (Adet) Price (Pcs)	Koli/Mt Box/Mt
Liner Alın Profili - 2,5 mt Liner Lock Profile-2,5 mt	ATS HDU087	2,00 €	125 mm

Not / Note

HAVUZ CAM MOZAİK TUTAMAK & KAYMAZLAR POOL GLASS MOSAIC TILES HANDLES & ANTISLIPS

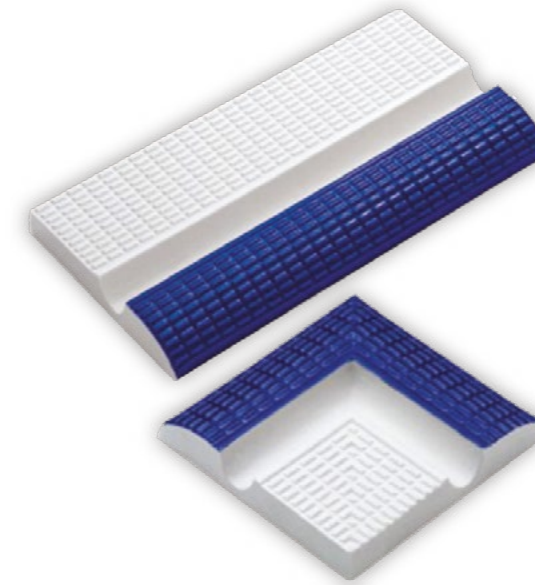
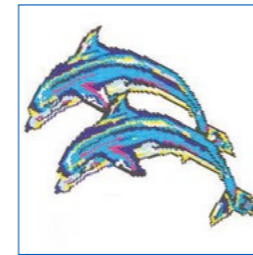
CAM MOZAİK
GLASS MOSAIC

Çizgili Tutamaklar
Striped Handle



Malzeme Cinsi Description	Kod Code	Fiyat (Adet) Price (Pcs)	Kg /Adet Kg/Pcs	Koli/Adet Box/Pcs
12,5 x 25 cm Çizgili Havuz Tutamağı 12,5 x 25 cm Striped Pool Handle	ATS HDU113	10,00 €		1
12,5 x 12,5 cm Çizgili Havuz Tutamağı İç Köşe 12,5 x 12,5 cm Striped Pool Handle Inner Corner	ATS HDU114	19,00 €		1
12,5 x 12,5 cm Çizgili Havuz Tutamağı Dış Köşe 12,5 x 12,5 cm Striped Pool Handle Outer Corner	ATS HDU115	19,00 €		1
25 x 25 cm Çizgili Havuz Tutamağı 25 x 25 cm Striped Pool Handle	ATS HDU116	13,00 €		1
25 x 25 cm Çizgili Havuz Tutamağı İç Köşe 25 x 25 cm Striped Pool Handle Inner Corner	ATS HDU117	24,00 €		1
25 x 25 cm Çizgili Havuz Tutamağı İç Köşe 25 x 25 cm Striped Pool Handle Outer Corner	ATS HDU118	24,00 €		1

Pötikare Tutamaklar
Petit Carre Handle

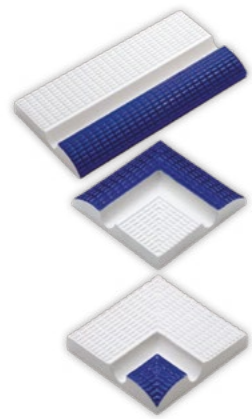

Malzeme Cinsi Description	Kod Code	Fiyat (Adet) Price (Pcs)	Kg /Adet Kg/Pcs	Koli/Adet Box/Pcs
12,5 x 25 cm Pötikare Havuz Tutamağı 12,5 x 25 cm Petit Carre Pool Handle	ATS HDU119	15,00 €		1
12,5 x 12,5 cm Pötikare Havuz Tutamağı İç Köşe 12,5 x 12,5 cm Petit Carre Pool Handle Inner Corner	ATS HDU120	28,00 €		1
12,5 x 12,5 cm Pötikare Havuz Tutamağı Dış Köşe 12,5 x 12,5 cm Petit Carre Pool Handle Outer Corner	ATS HDU121	28,00 €		1
25 x 25 cm Pötikare L Havuz Tutamağı 25 x 25 cm Petit Carre Pool Handle L	ATS HDU122	21,00 €		1
25 x 25 cm Pötikare L Havuz Tutamağı İç Köşe 25 x 25 cm Petit Carre Pool Handle Inner Corner L	ATS HDU123	40,00 €		1
25 x 25 cm Pötikare L Havuz Tutamağı Dış Köşe 25 x 25 cm Petit Carre Pool Handle Outer Corner L	ATS HDU124	40,00 €		1

Çizgili Kaymazlar
Striped Handle



Malzeme Cinsi Description	Kod Code	Fiyat (Adet) Price (Pcs)	Kg /Adet Kg/Pcs	Koli/Adet Box/Pcs
12,5 x 25 cm Çizgili Havuz Kaymazı 12,5 x 25 cm Striped Pool Antislip	ATS HDU125	1,50 €		1
12,5 x 12,5 cm Çizgili Havuz Kaymaz Köşe 12,5x12,5 cm Striped Pool Antislip Corner	ATS HDU126	2,50 €		1

Pötikare Kaymazlar
Petit Carre Antislip



Malzeme Cinsi Description	Kod Code	Fiyat (Adet) Price (Pcs)	Kg /Adet Kg/Pcs	Koli/Adet Box/Pcs
12,5 x 25 cm Pötikare Havuz Kaymazı 12,5 x 25 cm Petit Carre Pool Antislip	ATS HDU127	2,50 €		1
12,5 x 12,5 cm Pötikare Havuz Kaymaz Köşe 12,5x12,5 cm Petit Carre Pool Antislip Corner	ATS HDU128	5,00 €		1
25 x 25 cm Pötikare L Havuz Kaymazı 25 x 25 cm Petit Carre Pool Antislip L	ATS HDU129	40,00 €		1
25 x 25 cm Pötikare L Havuz Kaymaz İç Köşe 25 x 25 cm Petit Carre Pool Antislip Inner Corner L	ATS HDU130	76,00 €		1
25 x 25 cm Pötikare L Havuz Kaymaz Dış Köşe 25 x 25 cm Petit Carre Pool Antislip Outer Corner L	ATS HDU131	76,00 €		1

Ebru Serisi
Ebru Serie

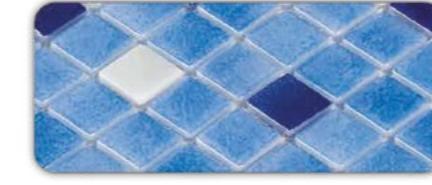

Malzeme Cinsi Description	Kod Code	Fiyat (Adet) Price (Pcs)	Ölçü Measure
Cam Tipi 4.5 mm Ebru Serisi Glass Type 4.5 mm Ebru Serie Mosaic Tile	ATS HVZ005	20,00 €	25x25 mm

Malzeme Cinsi Description	Kod Code	Fiyat (Adet) Price (Pcs)	Ölçü Measure
Cam Tipi 4.5 mm Ebru Serisi Glass Type 4.5 mm Ebru Serie Mosaic Tile	ATS HVZ025	20,00 €	25x25 mm

Malzeme Cinsi Description	Kod Code	Fiyat (Adet) Price (Pcs)	Ölçü Measure
Cam Tipi 4.5 mm Ebru Serisi Glass Type 4.5 mm Ebru Serie Mosaic Tile	ATS HVZ026	20,00 €	25x25 mm

Malzeme Cinsi Description	Kod Code	Fiyat (Adet) Price (Pcs)	Ölçü Measure
Cam Tipi 4.5 mm Ebru Serisi Glass Type 4.5 mm Ebru Serie Mosaic Tile	ATS HVZ027	20,00 €	25x25 mm

Malzeme Cinsi Description	Kod Code	Fiyat (Adet) Price (Pcs)	Ölçü Measure
Cam Tipi 4.5 mm Ebru Serisi Glass Type 4.5 mm Ebru Serie Mosaic Tile	ATS HVZ028	20,00 €	25x25 mm

Malzeme Cinsi Description	Kod Code	Fiyat (Adet) Price (Pcs)	Ölçü Measure
Cam Tipi 4.5 mm Ebru Serisi Glass Type 4.5 mm Ebru Serie Mosaic Tile	ATS HVZ029	20,00 €	25x25 mm

Malzeme Cinsi Description	Kod Code	Fiyat (Adet) Price (Pcs)	Ölçü Measure
Cam Tipi 4.5 mm Ebru Serisi Glass Type 4.5 mm Ebru Serie Mosaic Tile	ATS HVZ030	20,00 €	25x25 mm

Ebru Serisi
Ebru Serie

Malzeme Cinsi Description	Kod Code	Fiyat (Adet) Price (Pcs)	Ölçü Measure
Cam Tipi 4.5 mm Ebru Serisi Glass Type 4.5 mm Ebru Serie Mosaic Tile	ATS HVZ031	20,00 €	25x25 mm



Malzeme Cinsi Description	Kod Code	Fiyat (Adet) Price (Pcs)	Ölçü Measure
Cam Tipi 4.5 mm Ebru Serisi Glass Type 4.5 mm Ebru Serie Mosaic Tile	ATS HVZ032	20,00 €	25x25 mm



Malzeme Cinsi Description	Kod Code	Fiyat (Adet) Price (Pcs)	Ölçü Measure
Cam Tipi 4.5 mm Ebru Serisi Glass Type 4.5 mm Ebru Serie Mosaic Tile	ATS HVZ037	20,00 €	25x25 mm



Malzeme Cinsi Description	Kod Code	Fiyat (Adet) Price (Pcs)	Ölçü Measure
Cam Tipi 4.5 mm Ebru Serisi Glass Type 4.5 mm Ebru Serie Mosaic Tile	ATS HVZ052	20,00 €	25x25 mm



Malzeme Cinsi Description	Kod Code	Fiyat (Adet) Price (Pcs)	Ölçü Measure
Cam Tipi 4.5 mm Ebru Serisi Glass Type 4.5 mm Ebru Serie Mosaic Tile	ATS HVZ053	20,00 €	25x25 mm



Malzeme Cinsi Description	Kod Code	Fiyat (Adet) Price (Pcs)	Ölçü Measure
Cam Tipi 4.5 mm Ebru Serisi Glass Type 4.5 mm Ebru Serie Mosaic Tile	ATS HVZ060	20,00 €	25x25 mm



Malzeme Cinsi Description	Kod Code	Fiyat (Adet) Price (Pcs)	Ölçü Measure
Cam Tipi 4.5 mm Ebru Serisi Glass Type 4.5 mm Ebru Serie Mosaic Tile	ATS HVZ081	20,00 €	25x25 mm

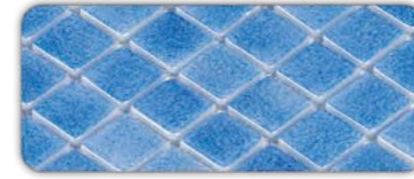

Malzeme Cinsi Description	Kod Code	Fiyat (Adet) Price (Pcs)	Ölçü Measure
Cam Tipi 4.5 mm Ebru Serisi Glass Type 4.5 mm Ebru Serie Mosaic Tile	ATS HVZ080	20,00 €	25x25 mm

Ebru Serisi
Ebru Serie

Malzeme Cinsi Description	Kod Code	Fiyat (Adet) Price (Pcs)	Ölçü Measure
Cam Tipi 4.5 mm Ebru Serisi Glass Type 4.5 mm Ebru Serie Mosaic Tile	ATS HVZ082	20,00 €	25x25 mm

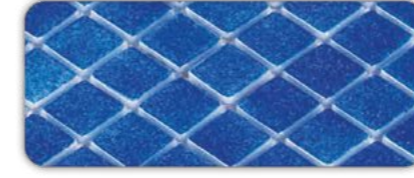

Malzeme Cinsi Description	Kod Code	Fiyat (Adet) Price (Pcs)	Ölçü Measure
Cam Tipi 4.5 mm Ebru Serisi Glass Type 4.5 mm Ebru Serie Mosaic Tile	ATS HVZ083	20,00 €	25x25 mm



Malzeme Cinsi Description	Kod Code	Fiyat (Adet) Price (Pcs)	Ölçü Measure
Cam Tipi 4.5 mm Ebru Serisi Glass Type 4.5 mm Ebru Serie Mosaic Tile	ATS HVZ117	20,00 €	25x25 mm



Malzeme Cinsi Description	Kod Code	Fiyat (Adet) Price (Pcs)	Ölçü Measure
Cam Tipi 4.5 mm Ebru Serisi Glass Type 4.5 mm Ebru Serie Mosaic Tile	ATS HVZ118	20,00 €	25x25 mm

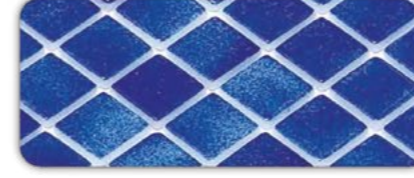

Malzeme Cinsi Description	Kod Code	Fiyat (Adet) Price (Pcs)	Ölçü Measure
Cam Tipi 4.5 mm Ebru Serisi Glass Type 4.5 mm Ebru Serie Mosaic Tile	ATS HVZ119	20,00 €	25x25 mm

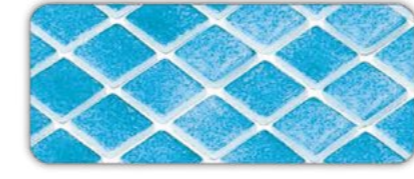

Malzeme Cinsi Description	Kod Code	Fiyat (Adet) Price (Pcs)	Ölçü Measure
Cam Tipi 4.5 mm Ebru Serisi Glass Type 4.5 mm Ebru Serie Mosaic Tile	ATS HVZ137	20,00 €	25x25 mm

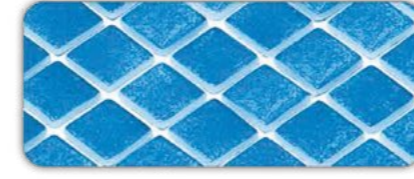

Malzeme Cinsi Description	Kod Code	Fiyat (Adet) Price (Pcs)	Ölçü Measure
Cam Tipi 4.5 mm Ebru Serisi Glass Type 4.5 mm Ebru Serie Mosaic Tile	ATS HVZ138	20,00 €	25x25 mm



Malzeme Cinsi Description	Kod Code	Fiyat (Adet) Price (Pcs)	Ölçü Measure
Cam Tipi 4.5 mm Ebru Serisi Glass Type 4.5 mm Ebru Serie Mosaic Tile	ATS HVZ109	30,00 €	25x25 mm

Ebru Serisi

Ebru Serie



Malzeme Cinsi Description	Kod Code	Fiyat (Adet) Price (Pcs)	Ölçü Measure
Cam Tipi 4.5 mm Ebru Serisi Glass Type 4.5 mm Ebru Serie Mosaic Tile	ATS HVZ183	30,00 €	25x25 mm



Malzeme Cinsi Description	Kod Code	Fiyat (Adet) Price (Pcs)	Ölçü Measure
Cam Tipi 4.5 mm Ebru Serisi Glass Type 4.5 mm Ebru Serie Mosaic Tile	ATS HVZ184	30,00 €	25x25 mm



Malzeme Cinsi Description	Kod Code	Fiyat (Adet) Price (Pcs)	Ölçü Measure
Cam Tipi 4.5 mm Ebru Serisi Glass Type 4.5 mm Ebru Serie Mosaic Tile	ATS HVZ185	30,00 €	25x25 mm



Malzeme Cinsi Description	Kod Code	Fiyat (Adet) Price (Pcs)	Ölçü Measure
Cam Tipi 4.5 mm Ebru Serisi Glass Type 4.5 mm Ebru Serie Mosaic Tile	ATS HVZ186	30,00 €	25x25 mm



Malzeme Cinsi Description	Kod Code	Fiyat (Adet) Price (Pcs)	Ölçü Measure
Cam Tipi 4.5 mm Ebru Serisi Glass Type 4.5 mm Ebru Serie Mosaic Tile	ATS HVZ187	30,00 €	25x25 mm



Malzeme Cinsi Description	Kod Code	Fiyat (Adet) Price (Pcs)	Ölçü Measure
Cam Tipi 4.5 mm Ebru Serisi Glass Type 4.5 mm Ebru Serie Mosaic Tile	ATS HVZ188	30,00 €	25x25 mm

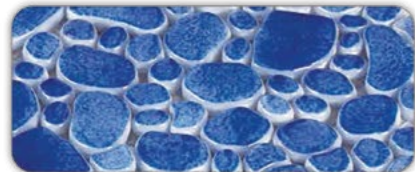

Malzeme Cinsi Description	Kod Code	Fiyat (Adet) Price (Pcs)	Ölçü Measure
Cam Tipi 4.5 mm Ebru Serisi Glass Type 4.5 mm Ebru Serie Mosaic Tile	ATS HVZ341	58,00 €	25x25 mm

Desen Serisi

Pattern Serie

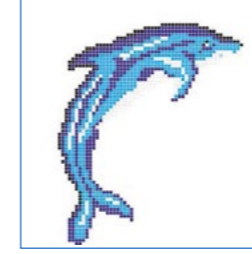

Malzeme Cinsi Description	Kod Code	Fiyat (Adet) Price (Pcs)	Ölçü Measure	Desen Ölçü Pattern Measure
Cam Tipi 4.5 mm Desen Serisi Glass Type 4.5 mm Pattern Serie Mosaic Tile	ATS HVZ705	200,00 €	25x25 mm	158x189 mm



Malzeme Cinsi Description	Kod Code	Fiyat (Adet) Price (Pcs)	Ölçü Measure	Desen Ölçü Pattern Measure
Cam Tipi 4.5 mm Desen Serisi Glass Type 4.5 mm Pattern Serie Mosaic Tile	ATS HVZ706	200,00 €	25x25 mm	158x189 mm



Malzeme Cinsi Description	Kod Code	Fiyat (Adet) Price (Pcs)	Ölçü Measure	Desen Ölçü Pattern Measure
Cam Tipi 4.5 mm Desen Serisi Glass Type 4.5 mm Pattern Serie Mosaic Tile	ATS HVZ707	700,00 €	25x25 mm	267x400 mm



Malzeme Cinsi Description	Kod Code	Fiyat (Adet) Price (Pcs)	Ölçü Measure	Desen Ölçü Pattern Measure
Cam Tipi 4.5 mm Desen Serisi Glass Type 4.5 mm Pattern Serie Mosaic Tile	ATS HVZ708	450,00 €	25x25 mm	252x283 mm



Malzeme Cinsi Description	Kod Code	Fiyat (Adet) Price (Pcs)	Ölçü Measure	Desen Ölçü Pattern Measure
Cam Tipi 4.5 mm Desen Serisi Glass Type 4.5 mm Pattern Serie Mosaic Tile	ATS HVZ709	180,00 €	25x25 mm	100x238 mm



Malzeme Cinsi Description	Kod Code	Fiyat (Adet) Price (Pcs)	Ölçü Measure	Desen Ölçü Pattern Measure
Cam Tipi 4.5 mm Desen Serisi Glass Type 4.5 mm Pattern Serie Mosaic Tile	ATS HVZ710	550,00 €	25x25 mm	284x284 mm

Desen Serisi
Pattern Serie

Malzeme Cinsi Description	Kod Code	Fiyat (Adet) Price (Pcs)	Ölçü Measure	Yükseklik Height
Cam Tipi 4.5 mm Desen Serisi Glass Type 4.5 mm Pattern Serie Mosaic Tile	ATS KS006	63,00 €	25x25 mm	31,5 mm

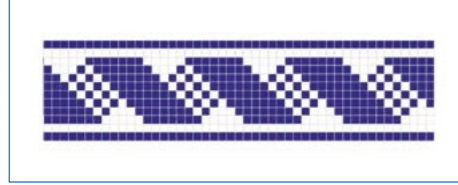

Malzeme Cinsi Description	Kod Code	Fiyat (Adet) Price (Pcs)	Ölçü Measure	Yükseklik Height
Cam Tipi 4.5 mm Desen Serisi Glass Type 4.5 mm Pattern Serie Mosaic Tile	ATS KS014	63,00 €	25x25 mm	31,5 mm



Malzeme Cinsi Description	Kod Code	Fiyat (Adet) Price (Pcs)	Ölçü Measure	Yükseklik Height
Cam Tipi 4.5 mm Desen Serisi Glass Type 4.5 mm Pattern Serie Mosaic Tile	ATS KS019	63,00 €	25x25 mm	31,5 mm

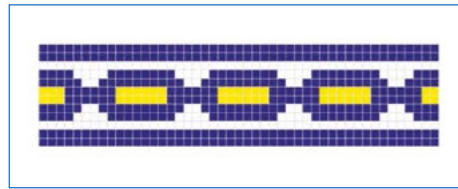

Malzeme Cinsi Description	Kod Code	Fiyat (Adet) Price (Pcs)	Ölçü Measure	Yükseklik Height
Cam Tipi 4.5 mm Desen Serisi Glass Type 4.5 mm Pattern Serie Mosaic Tile	ATS KS028	63,00 €	25x25 mm	31,5 mm

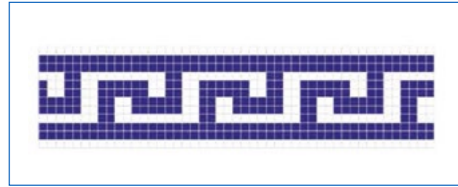

Malzeme Cinsi Description	Kod Code	Fiyat (Adet) Price (Pcs)	Ölçü Measure	Yükseklik Height
Cam Tipi 4.5 mm Desen Serisi Glass Type 4.5 mm Pattern Serie Mosaic Tile	ATS KS050	63,00 €	25x25 mm	31,5 mm

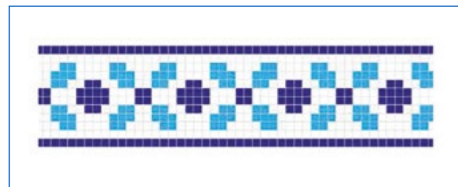

Malzeme Cinsi Description	Kod Code	Fiyat (Adet) Price (Pcs)	Ölçü Measure	Yükseklik Height
Cam Tipi 4.5 mm Desen Serisi Glass Type 4.5 mm Pattern Serie Mosaic Tile	ATS KS051	63,00 €	25x25 mm	31,5 mm

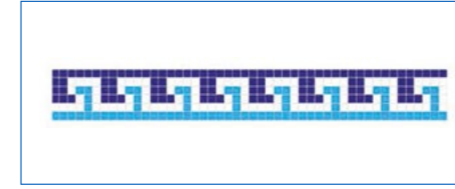

Malzeme Cinsi Description	Kod Code	Fiyat (Adet) Price (Pcs)	Ölçü Measure	Yükseklik Height
Cam Tipi 4.5 mm Desen Serisi Glass Type 4.5 mm Pattern Serie Mosaic Tile	ATS BD005	63,00 €	25x25 mm	16 mm

Desen Serisi
Pattern Serie

Malzeme Cinsi Description	Kod Code	Fiyat (Adet) Price (Pcs)	Ölçü Measure	Yükseklik Height
Cam Tipi 4.5 mm Desen Serisi Glass Type 4.5 mm Pattern Serie Mosaic Tile	ATS BD006	63,00 €	25x25 mm	16 mm

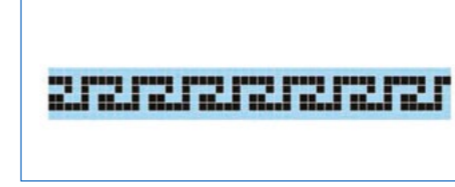

Malzeme Cinsi Description	Kod Code	Fiyat (Adet) Price (Pcs)	Ölçü Measure	Yükseklik Height
Cam Tipi 4.5 mm Desen Serisi Glass Type 4.5 mm Pattern Serie Mosaic Tile	ATS BD011	63,00 €	25x25 mm	16 mm



Malzeme Cinsi Description	Kod Code	Fiyat (Adet) Price (Pcs)	Ölçü Measure	Yükseklik Height
Cam Tipi 4.5 mm Desen Serisi Glass Type 4.5 mm Pattern Serie Mosaic Tile	ATS BD024	63,00 €	25x25 mm	16 mm

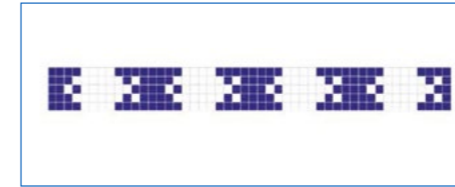

Malzeme Cinsi Description	Kod Code	Fiyat (Adet) Price (Pcs)	Ölçü Measure	Yükseklik Height
Cam Tipi 4.5 mm Desen Serisi Glass Type 4.5 mm Pattern Serie Mosaic Tile	ATS BD033	63,00 €	25x25 mm	16 mm



Malzeme Cinsi Description	Kod Code	Fiyat (Adet) Price (Pcs)	Ölçü Measure	Yükseklik Height
Cam Tipi 4.5 mm Desen Serisi Glass Type 4.5 mm Pattern Serie Mosaic Tile	ATS BD036	63,00 €	25x25 mm	16 mm

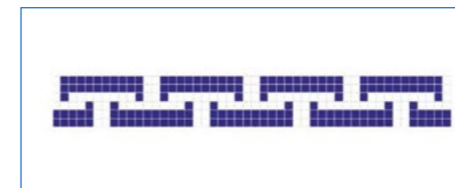

Malzeme Cinsi Description	Kod Code	Fiyat (Adet) Price (Pcs)	Ölçü Measure	Yükseklik Height
Cam Tipi 4.5 mm Desen Serisi Glass Type 4.5 mm Pattern Serie Mosaic Tile	ATS BD039	63,00 €	25x25 mm	16 mm



Malzeme Cinsi Description	Kod Code	Fiyat (Adet) Price (Pcs)	Ölçü Measure	Yükseklik Height
Cam Tipi 4.5 mm Desen Serisi Glass Type 4.5 mm Pattern Serie Mosaic Tile	ATS BD040	63,00 €	25x25 mm	16 mm

Not / Note

OLİMPİK HAVUZ MALZEMELERİ OLYMPIC POOL EQUIPMENTS



OLİMPİK
OLYMPIC

Polyester Sabit Atlama Platformu

Polyester Starting Block



Malzeme Cinsi Description	Kod Code	Fiyat (Adet) Price (Pcs)	Kg /Adet Kg/Pcs	Koli/Adet Box/Pcs
400 mm'lik Platform-Polyester 400 mm Platform-Polyester	ATS OLP046	350,00 €		1
700 mm'lik Platform-Polyester (Sabit) 700 mm Platform-Polyester	ATS OLP047	480,00 €		1

Polyester Ayarlanabilir Atlama Platformu

Polyester Adjustable Starting Block



Malzeme Cinsi Description	Kod Code	Fiyat (Adet) Price (Pcs)	Kg /Adet Kg/Pcs	Koli/Adet Box/Pcs
400 mm'lik Platform-AISI 304 400 mm Platform-AISI 304	ATS OLP048	1.680,00 €		1

Paslanmaz Sabit Atlama Platformu

Stainless Steel Fixed Starting Block



Malzeme Cinsi Description	Kod Code	Fiyat (Adet) Price (Pcs)	Kg /Adet Kg/Pcs	Koli/Adet Box/Pcs
400 mm'lik Platform-AISI 304 400 mm Platform- AISI 304	ATS OLP001	555,00 €	10,50	1
700 mm'lik Platform-AISI 304 700 mm Platform- AISI 304	ATS OLP002	770,00 €	11,00	1
400 mm'lik Platform-AISI 316 400 mm Platform- AISI 316	ATS OLP003	750,00 €	10,50	1
700 mm'lik Platform-AISI 316 700 mm Platform- AISI 316	ATS OLP004	1.050,00 €	11,00	1

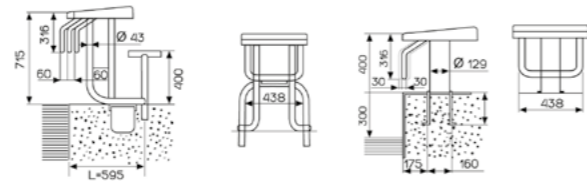

Paslanmaz Ayarlanabilir Atlama Platformu

Adjustable Starting Block



Malzeme Cinsi Description	Kod Code	Fiyat (Adet) Price (Pcs)	Kg /Adet Kg/Pcs	Koli/Adet Box/Pcs
400 mm'lik Platform-AISI 304 400 mm Platform- AISI 304	ATS OLP005	700,00 €	17,50	1
700 mm'lik Platform-AISI 304 700 mm Platform- AISI 304	ATS OLP006	950,00 €	23,00	1
400 mm'lik Platform-AISI 316 400 mm Platform- AISI 316	ATS OLP007	950,00 €	17,50	1
700 mm'lik Platform-AISI 316 700 mm Platform- AISI 316	ATS OLP008	1.280,00 €	23,00	1

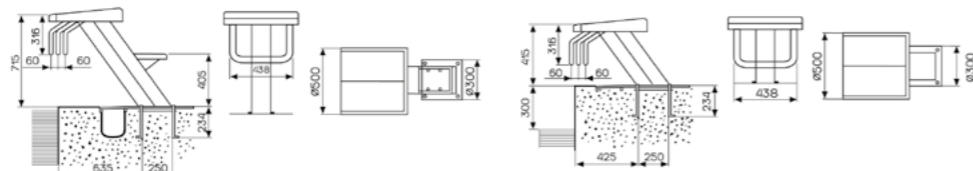

Dönüş Panelleri

Return Panel



Malzeme Cinsi Description	Kod Code	Fiyat (Adet) Price (Pcs)	Kg /Adet Kg/Pcs	Koli/Adet Box/Pcs
Dönüş Paneli - Genişlik 2 m Return Panel - Width 2 m	ATS OLP009	460,00 €	12,000	1
Dönüş Paneli - Genişlik 2,5 m Return Panel - Width 2,5 m	ATS OLP010	490,00 €	14,000	1
Panel Desteği AISI 304 Paslanmaz Çelik Panel Bracket AISI 304 Stainless Steel	ATS OLP011	300,00 €	7,000	1

Dönüş Panelleri - Plastik Kafes Bölmeli, Aisi 304 Kalite Paslanmaz Çelik Çerçevesi. Yükseklik : 300 Mm.
Panel Desteği Hariç.
Not: Paslanmaz Çelik Ankrajlar Fiyata Dahil Değildir

Return Panels: Plastic cage partition, AISI 304 Stainless steel frame Height: 300mm.
Excluding Panel back up panel
Note: Stainless steel anchors are not included in the price.

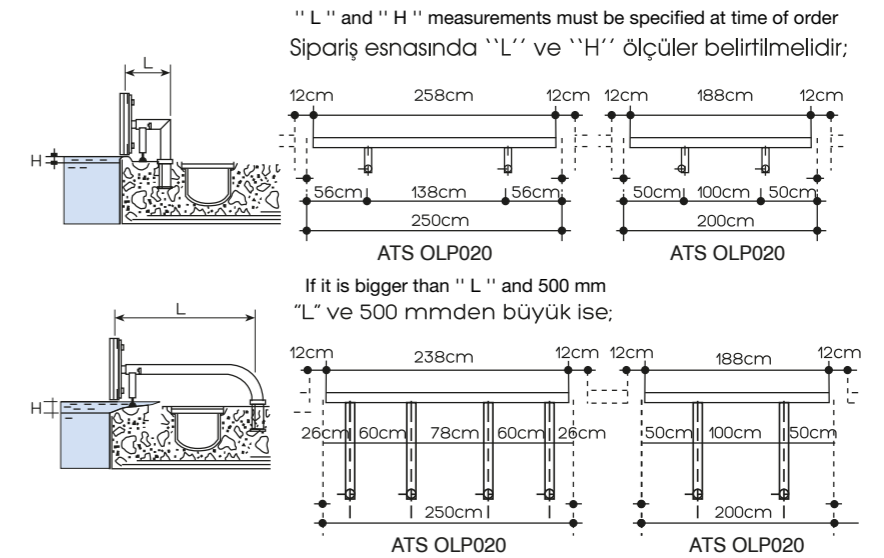

Geri Dönüş İşaret Direkleri

Faulty Starty Signal Posts



Malzeme Cinsi Description	Kod Code	Fiyat (Adet) Price (Pcs)	Kg /Adet Kg/Pcs	Koli/Adet Box/Pcs
İşaret Direği - 12,5 m-AISI 304 Signpost -12,5 m - AISI 304	ATS OLP012	294,00 €	16,000	1
İşaret Direği - 25 m-AISI 304 Signpost -25 m - AISI 304	ATS OLP013	355,00 €	14,000	1
İşaret Direği - 12,5 m - AISI 316 Signpost -12,5 m - AISI 316	ATS OLP014	396,00 €	16,000	1
İşaret Direği - 25 m - AISI 316 Signpost -25 m - AISI 316	ATS OLP015	478,00 €	14,000	1

Geri Dönüş İşaret Direkleri - AISI 304 Kalite Paslanmaz Çelik Ø42 Mm Borudan 2 Adet H= 1,8 M Direk, Plastik Halat Ve Bayrak-Lardan Oluşur. Havuz Genişliği 21 Mt İçin Ø43 Mm Boru, 25 Mt İçin Ø48 MmBoru Kullanılır.
Not: Paslanmaz Çelik Ankrajlar Fiyata Dahil Değildir.

Backstroke signpost - AISI 304 Stainless steel, set of it Ø42mm pipes 2 pieces h= 1,18 m signpost, plastic rob and flags Ø43 mm pipe for width 21 mt of pool Ø48 mm pipe for width 23 mt of pool
Note: Stainless Steel and anchors are not included in the price.

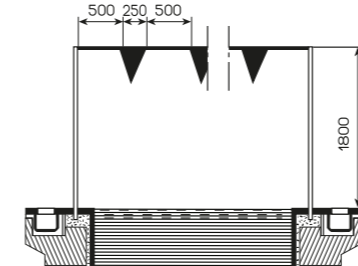

Yanlış Çıkış İşaret Direkleri False Start Signpost

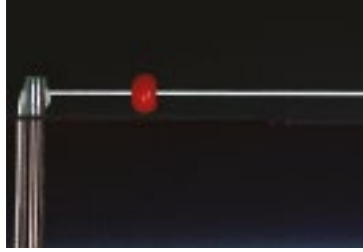

Malzeme Cinsi Description	Kod Code	Fiyat (Adet) Price (Pcs)	Kg /Adet Kg/Pcs	Koli/Adet Box/Pcs
İşaret Direği - 12,5 m-AISI 304 Signpost -12,5 m - AISI 304	ATS OLP016	294,00 €	12,000	1
İşaret Direği - 25 m-AISI 304 Signpost -25 m - AISI 304	ATS OLP017	355,00 €	14,000	1
İşaret Direği - 12,5 m - AISI 316 Signpost -12,5 m - AISI 316	ATS OLP018	396,00 €	12,000	1
İşaret Direği - 25 m - AISI 316 Signpost -25 m - AISI 316	ATS OLP019	478,00 €	14,000	1

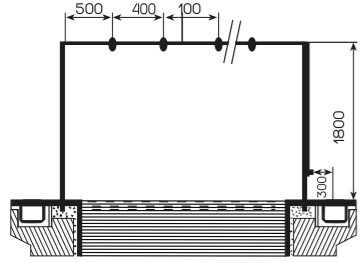

Yanlış Çıkış İşaret Direkleri - AISI 304 Paslanmaz Çelik Ø42 Mm Borudan 2 Adet H= 1,8 M Direk. Plastik Halat, Top ve Şaman-Dıralardan Oluşur. Havuz Genişliği 21 Mt İçin Ø43 Mm Boru, 25 Mt İçin Ø48 Mm Boru Kullanılır. Not: Paslanmaz Çelik Ankrajlar Fiyata Dahil Değildir.

False start signpost AISI 304 Stainless steel Ø 42 mm h:18 m 2 pieces pipes consist of plastic rope, ball and float Ø43 mm pipe for width 21 mt of pool Ø 48 mm pipe for width 25 mt of pool. Note: Stainless steel and anchors are not included in the price.

Ankrajlar Lane Rope Anchor



Malzeme Cinsi Description	Kod Code	Fiyat (Adet) Price (Pcs)	Kg /Adet Kg/Pcs	Koli/Adet Box/Pcs
Düz Ankraj Horizontal Flanch Anchoring Socket	ATS OLP020	50,00 €	1,020	1
Eğik Ankraj Angled Flanged Anchoring Socket	ATS OLP021	50,00 €	1,020	1



Malzeme Cinsi Description	Kod Code	Fiyat (Adet) Price (Pcs)	Kg /Adet Kg/Pcs	Koli/Adet Box/Pcs
Su Üstü Askı Parçası Ankraj Overhead Bracket	ATS OLP022	50,00 €	0,520	1

Paslanmaz çelik ankrajlarla birlikte üstten taşma havuzlarda seperatörün takılması içindir. For installing the separator in overflow pools with stainless steel anchors.



Malzeme Cinsi Description	Kod Code	Fiyat (Adet) Price (Pcs)	Kg /Adet Kg/Pcs	Koli/Adet Box/Pcs
Askı Kancalı Ankraj Anchoring Cup With Central Rod	ATS OLP023	55,00 €	0,460	1



Malzeme Cinsi Description	Kod Code	Fiyat (Adet) Price (Pcs)	Kg /Adet Kg/Pcs	Koli/Adet Box/Pcs
Pistonlu Düz Ankraj Piston Flat Anchor	ATS OLP024	55,00 €	0,566	1

Havuz perdesi için, paslanmaz seperatör ankraji. Stainless steel separator anchor for pool curtain.

Roma Model Kulvar Seperatörleri Roma Model Lane Rope Accessor

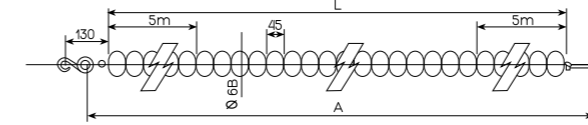

Malzeme Cinsi Description	Kod Code	Fiyat (Adet) Price (Pcs)	Kg /Adet Kg/Pcs	Koli/Adet Box/Pcs
Kulvar Seperatörü - Uzunluk 25 m Lane Separator - Lenght 25 m	ATS OLP025	360,00 €	8,700	1
Kulvar Seperatörü - Uzunluk 50 m Lane Separator - Lenght 50 m	ATS OLP026	720,00 €	14,400	1

Plastik toplar, polyester ip ve bir adet kancası ile komple. 1 metresinde 24 adet seperatör topu vardır. Lane set: Plastic ball Polyester rope and hook. There are 24 seperator balls in 1 m.

Kod Code	L (m)	A (m)	Renkli Roma Seperatör Adedi Coloured Roma Seperator Pieces	Beyaz Seperatör Adedi White Seperator Pieces
ATS OLP025	25	27	232	318
ATS OLP026	50	52	232	868

Seul Model Kulvar Seperatörleri Seul Model Lane Rope Accessor

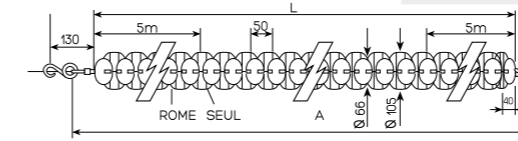

Malzeme Cinsi Description	Kod Code	Fiyat (Adet) Price (Pcs)	Kg /Adet Kg/Pcs	Koli/Adet Box/Pcs
Kulvar Seperatörü - Uzunluk 25 m Lane Separator - Lenght 25 m	ATS OLP027	500,00 €	23,700	1
Kulvar Seperatörü - Uzunluk 50 m Lane Separator - Lenght 50 m	ATS OLP028	850,00 €	47,400	1

Plastik toplar, polyester ip ve bir adet kancası ile komple. 1 metresinde 19 adet seperatör top, 19 adet seperatör elemanı vardır. Lane Set: Plastic ball Polyester rope and hook. There are 19 seperator ball and 19 seperator sections in 1 m.

Kod Code	L (m)	A (m)	Renkli Seul Seperatör Adedi Coloured Seul Seperator Pieces	Beyaz Roma Seperatör Adedi White Roma Seperator Pieces	Beyaz Seul Seperatör Adedi White Seul Seperator Pieces	Renkli Roma Seperatör Adedi Coloured Roma Seperator Pieces
ATS OLP027	25	27	178	178	268	269
ATS OLP028	50	52	178	178	174	715

Moskova Model Kulvar Seperatörleri Moscow Model Lane Rope Accessor

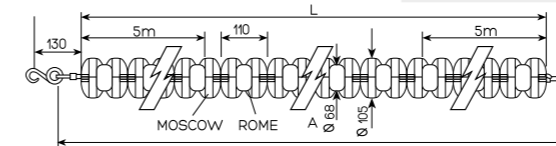

Malzeme Cinsi Description	Kod Code	Fiyat (Adet) Price (Pcs)	Kg /Adet Kg/Pcs	Koli/Adet Box/Pcs
Kulvar Seperatörü - Uzunluk 25 m Lane Separator - Lenght 25 m	ATS OLP029	550,00 €	23,700	1
Kulvar Seperatörü - Uzunluk 50 m Lane Separator - Lenght 50 m	ATS OLP030	1.200,00 €	47,400	1

Plastik toplar, polyester ip ve bir adet kancası ile komple. 1 metresinde 19 adet seperatör top, 19 adet seperatör elemanı vardır. Lane Set: Plastic ball Polyester rope and hook. There are 19 seperator ball and 19 seperator sections in 1 m.

Kod Code	L (m)	A (m)	Renkli Seul Seperatör Adedi Coloured Seul Seperator Pieces	Beyaz Roma Seperatör Adedi White Roma Seperator Pieces	Beyaz Seul Seperatör Adedi White Seul Seperator Pieces	Renkli Roma Seperatör Adedi Coloured Roma Seperator Pieces
ATS OLP029	25	27	192	96	192	143
ATS OLP030	50	52	192	96	192	378

Hakem ve Cankurtaran Koltuğu

Referee and Lifeguard Chair



Malzeme Cinsi Description	Kod Code	Fiyat (Adet) Price (Pcs)	Kg /Adet Kg/Pcs	Koli/Adet Box/Pcs
Hakem ve Cankurtaran Koltuğu AISI 304 Life Guarde And Referee Chair AISI 304	ATS OLP031	1.705,00 €		1
Hakem ve Cankurtaran Koltuğu AISI 316 Life Guarde And Referee Chair AISI 316	ATS OLP032	2.300,00 €		1

Not : Ø43 mm borudan imal edilmiştir. Note: It is made of Ø43 mm pipe.

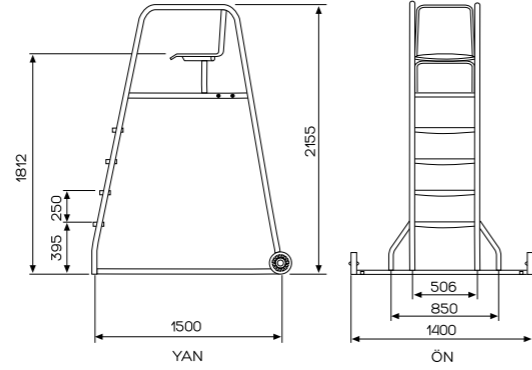

Kromajlı Seperatör Aksamları

Chromated Separator Parts



Malzeme Cinsi Description	Kod Code	Fiyat (Adet) Price (Pcs)	Kg /Adet Kg/Pcs	Koli/Adet Box/Pcs
Yaylı Model Bronz Döküm Kromajlı Gerdirci Spring Model Sunborn and Chrome Casting Ratchet	ATS OLP037	195,00 €	0,686	1



Malzeme Cinsi Description	Kod Code	Fiyat (Adet) Price (Pcs)	Kg /Adet Kg/Pcs	Koli/Adet Box/Pcs
İşkence Model AISI 304 P.Ç İki Ucu Kancalı Gerdirci Double Edged Hooked Brass AISI 304	ATS OLP038	50,00 €	0,182	1

Seperatör Toplama Arabası

Separator Collection Trolley

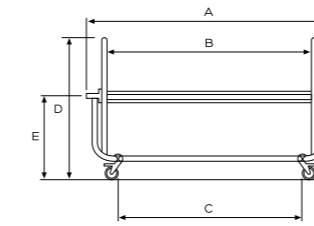
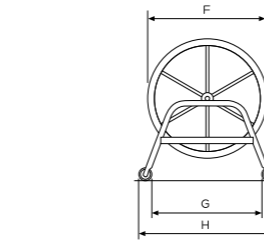

Malzeme Cinsi Description	Kod Code	Fiyat (Adet) Price (Pcs)	Kg /Adet Kg/Pcs	Koli/Adet Box/Pcs
Seperatör Toplama Çarkı - Genişlik 1,20 mt AISI 304 Lane Rope Roller Wheel - Width 1,20 mt AISI 304	ATS OLP033	1.600,00 €	25,00	1
Seperatör Toplama Çarkı - Genişlik 1,80 mt AISI 304 Lane Rope Roller Wheel - Width 1,80 mt AISI 304	ATS OLP034	1.750,00 €	30,00	1
Seperatör Toplama Çarkı - Genişlik 1,20 mt AISI 310 Lane Rope Roller Wheel - Width 1,20 mt AISI 310	ATS OLP035	2.160,00 €	25,00	1
Seperatör Toplama Çarkı - Genişlik 1,80 mt AISI 310 Lane Rope Roller Wheel - Width 1,80 mt AISI 310	ATS OLP036	2.370,00 €	30,00	1

Not : Ø43 mm borudan imal edilmiştir. Note: It is made of Ø43 mm pipe.

Uzunluk Length (mm)	A (m)	B (m)	C (m)	D (m)	E (m)	F (m)	G (m)	H (m)
1200 mm	1484	1135	974	1175	685	980	924	1130
1800 mm	2036	1684	1526	1175	685	980	924	1130

Seperatör Kapasitesi : Genişlik 1,80 m
Separator Capacity: Width 1.80 m

Seperatör Model Separator Model	25 m	50 m
Seul Model	6	3
Roma Model	12	6
Moskova Model	6	3

Seperatör Kapasitesi : Genişlik 1,20 m
Separator Capacity: Width 1.20 m

Seperatör Modeli Separator Model	25 m	50 m
Seul Model	4	2
Roma Model	8	4
Moskova Model	4	2

Malzeme Cinsi Description	Kod Code	Fiyat (Adet) Price (Pcs)	Kg /Adet Kg/Pcs	Koli/Adet Box/Pcs
Seperatör Toplama Arabası Düz Çengel AISI 304 P.Ç. Lane Rope Hook - AISI 304	ATS OLP039	15,00 €	0,048	1

Malzeme Cinsi Description	Kod Code	Fiyat (Adet) Price (Pcs)	Kg /Adet Kg/Pcs	Koli/Adet Box/Pcs
Seperatör Gerdirci Yaylı AISI 304 P.Ç. Lane Rope Spring AISI 304	ATS OLP040	160,00 €	0,048	1

Engelli Asansörü Disabled Access Ladders (Elevator)



Malzeme Cinsi Description	Kod Code	Fiyat (Adet) Price (Pcs)	Koli/Mt Box/Mt
Elektrikli Engelli Asansörü Electrical Disabled Access Ladders (Elevator)	ATS OLP044	7.350,00 €	280
Akülü Engelli Asansörü Battery-Powered Disabled Access Ladders (Elevator)	ATS OLP045	8.550,00 €	280

ATSOLP044 TEKNİK ÖZELLİKLER

Taşıma kapasitesi 120 kg dir.

Elektrik gereksinimi 220 V.

Ölçüleri ;Yükseklik 116 cm, En 90 cm, Boy 150 cm.

ATSOLP045 TEKNİK ÖZELLİKLER

Taşıma kapasitesi 120 kg dir.

Elektrik gereksinimi 12 V. Batarya 6mr0 40-60 kez.

Ölçüleri ;Yükseklik 116 cm, En 90 cm, Boy 150 cm.

KULLANIM ALANLARI

Havuz asansörü; yaşlı, engelli veya engelsiz tüm insanların otel, kaplıca ve benzeri tesislerin havuzlarına konforlu bir şekilde girip çıkmasını sağlayan son derece güvenli ve estetik modern bir taşıma aracıdır.



PASLANMAZ ve UZUN ÖMÜRLÜ

Tamamı sağlığı tehdit etmeyen paslanmaz malzemelerden üretilmiştir.

Bu sebeple hijyeniktir. Yapısında kullanılan 316 kalite paslanmaz çelik, teflon ve benzeri plastik malzemeler sayesinde sudan hiç bir şekilde etkilenmez.

Uzun süre su içerisinde kalabilir. Sabit montajlı değildir.

Özel taşınabilir forktifiyle birlikte tesisimizdeki her havuza rahatlıkla taşınabilir.

180° dönüş imkanı sağlar.



SÜS HAVUZU LAMBA VE FİSKİYELERİ FOUNTAIN EQUIPMENTS



Paslanmaz Sualtı Lambaları
 Stainless Steel Fountain Led Lights

Malzeme Cinsi Description	Kod Code	Fiyat (Adet) Price (Pcs)	Koli/Adet Box/Pcs
6W RGB -Tek Renk 6W RGB - Unicolor	ATS SUS205	96,00 €	1
9W RGB -Tek Renk 9W RGB - Unicolor	ATS SUS206	126,00 €	1
12W RGB -Tek Renk 12W RGB - Unicolor	ATS SUS207	134,00 €	1

Paslanmaz Köpük Nozulları
 Stainless Steel Foam Fountain Nozzle

Malzeme Cinsi Description	Kod Code	Fiyat (Adet) Price (Pcs)	Koli/Adet Box/Pcs	Giriş
20-10E	ATS SUS229	40,00 €	1	1/2 "
25-10E	ATS SUS230	50,00 €	1	3/4 "
30-10E	ATS SUS231	70,00 €	1	1 "
55-15E	ATS SUS232	200,00 €	1	1 1/2 "
75-20E	ATS SUS233	300,00 €	1	2 "

Ekonomik Ayaklı Power Ledli Süs Havuzu Lambaları

Malzeme Cinsi Description	Kod Code	Fiyat (Adet) Price (Pcs)	Koli/Adet Box/Pcs
Krom 6W/12V AC Tek Renkli Lamba - 6 Ledli Chrome 6W/12V AC Unicolor Light - 6 Leds	ATS SUS018	135,00 €	1
Krom 10W/12V AC Tek Renkli Lamba - 9 Ledli Chrome 10W/12V AC Unicolor Light - 9 Leds	ATS SUS019	150,00 €	1
Krom 10W/12V DC RGB Lamba - 6 Ledli Chrome 10W/12V DC RGB Light - 6 Leds	ATS SUS020	150,00 €	1
Krom 10W/12V DC RGB Lamba - 9 Ledli Chrome 10W/12V DC RGB Light - 9 Leds	ATS SUS021	160,00 €	1
Krom 10W/12V DC Full RGB Lamba - 6 Ledli Chrome 10W/12V DC Full RGB Light - 6 Leds	ATS SUS022	160,00 €	1
Krom 10W/12V DC Full RGB Lamba - 9 Ledli Chrome 10W/12V DC Full RGB Light - 9 Leds	ATS SUS023	175,00 €	1

Tek renk opsiyonları: Beyaz, Güneşli, Mavi, Yeşil, Kırmızı.

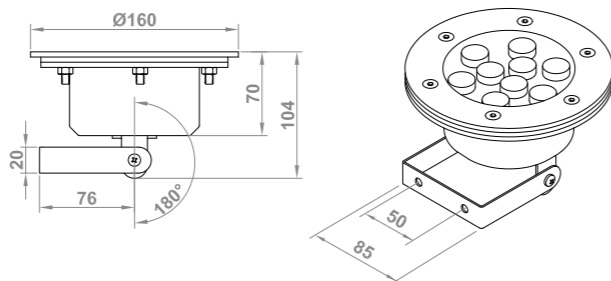
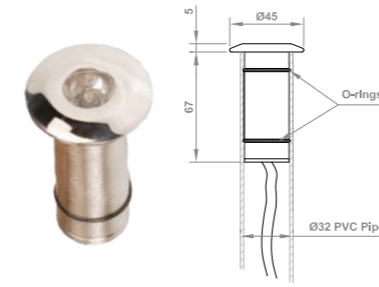
32 Boruya Geçmeli Tip Ledli Armatür
 LED Armature Mounted Ø32 Pipe

Malzeme Cinsi Description	Kod Code	Fiyat (Adet) Price (Pcs)	Koli/Adet Box/Pcs
Paslanmaz 1W/5V AC Tek Renkli Lamba - 1 Ledli Stainless 1W/5V AC Unicolor Light - 1 Led	ATS SUS024	52,00 €	1
Paslanmaz 1W/5V DC Full RGB Lamba - 1 Ledli Stainless 1W/5V DC Full RGB Light - 1 Led	ATS SUS025	62,00 €	1

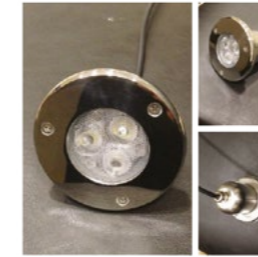
Paslanmaz Tip Ledli Armatür

Malzeme Cinsi Description	Kod Code	Fiyat (Adet) Price (Pcs)	Koli/Adet Box/Pcs
Paslanmaz 3W/12V AC Tek Renkli Lamba - 3 Power Ledli / Ø 63 Boruya Stainless 3W/12V AC Unicolor Light - 3 Power Leds / Ø63	ATS SUS089	110,00 €	1
Paslanmaz 3W/12V DC Full RGB Lamba - 3 Power Ledli / Ø 63 Boruya Stainless 3W/12V DC Full RGB Light - 3 Power Leds / Ø63	ATS SUS090	121,00 €	1
Paslanmaz 3W/12V AC Tek Renkli Lamba-3 Power Ledli / Ayaklı Stainless 3W/12V AC Unicolor Light - 3 Power Leds / Footed Light	ATS SUS091	113,00 €	1
Paslanmaz 3W/12V DC Full RGB Lamba-3 Power Ledli / Ayaklı Stainless 3W/12V DC Full RGB Light - 3 Power Leds / Footed Light	ATS SUS092	124,00 €	1

Krom Kaplama Ledli Armatür
 Chrome Framed Led Light Armature

Malzeme Cinsi Description	Kod Code	Fiyat (Adet) Price (Pcs)	Koli/Adet Box/Pcs
Krom Kaplama 3W/12V AC Tek Renkli Lamba - 3 Power Ledli / Ø 63 Boruya Chrome Plating 3W/12V AC Unicolor Light - 3 Power Leds / Ø63	ATS SUS026	85,00 €	1
Krom Kaplama 3W/12V DC Full RGB Lamba - 3 Power Ledli / Ø 63 Boruya Chrome Plating 3W/12V DC Full RGB Light - 3 Power Leds / Ø63	ATS SUS028	97,00 €	1
Krom Kaplama 3W/12V AC Tek Renkli Lamba - 3 Power Ledli / Ayaklı Chrome Plating 3W/12V AC Unicolor Light - 3 Power Leds / Footed Light	ATS SUS093	88,00 €	1
Krom Kaplama 3W/12V DC Full RGB Lamba - 3 Power Ledli / Ayaklı Chrome Plating 3W/12V DC Full RGB Light - 3 Power Leds / Footed Light	ATS SUS094	100,00 €	1

Komple Plastik Ledli Armatür
 Plastic Led Light Armature

Malzeme Cinsi Description	Kod Code	Fiyat (Adet) Price (Pcs)	Koli/Adet Box/Pcs
Plastik 3W/12V AC Tek Renkli Lamba - 3 Power Ledli / Ø 63 Boruya Plastic 3W/12V AC Unicolor Light - 3 Power Leds / Fit for Ø63 Pipe	ATS SUS035	52,00 €	1
Plastik 3W/12V DC Full RGB Lamba - 3 Power Ledli / Ø 63 Boruya Plastic 3W/12V DC Full RGB Light - 3 Power Leds / Fit for Ø63 Pipe	ATS SUS037	93,00 €	1
Plastik 3W/12V AC Tek Renkli Lamba - 3 Power Ledli / Ayaklı Plastic 3W/12V AC Unicolor Light - 3 Power Leds / Footed Light	ATS SUS096	54,00 €	1
Plastik 3W/12V DC Full RGB Lamba - 3 Power Ledli / Ayaklı Plastic 3W/12V DC Full RGB Light - 3 Power Leds / Footed Light	ATS SUS097	96,00 €	1

Tek Renk Opsiyonları
 Beyaz, Güneşli, Mavi, Yeşil, Kırmızı

Kablo Uzunluğu
 1,20 mt. IP 68 Korumalı

Krom Kaplamaların
 Gövdesi Plastik, sadece ön çerçeve kaplamadır.

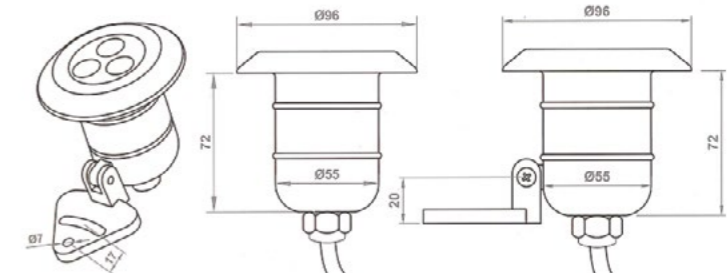

Özenli Kovanlı Tip Ledli Armatür
Special Type Led Light Armature With Niche



Malzeme Cinsi Description	Kod Code	Fiyat (Adet) Price (Pcs)	Koli/Adet Box/Pcs
Kovanlı 6W/12V AC Tek Renkli Lamba - 6 Power Ledli 6W/12V AC Unicolor Light with Niche - 6 Power Leds	ATS SUS029	155,00 €	1
Kovanlı 10W/12V AC Tek Renkli Lamba - 9 Power Ledli 10W/12V AC Unicolor Light with Niche - 9 Power Leds	ATS SUS030	165,00 €	1
Kovanlı 6W/12V AC Full RGB Lamba - 6 Power Ledli 6W/12V AC Full RGB Light with Niche - 6 Power Leds	ATS SUS033	180,00 €	1
Kovanlı 10W/12V DC Full RGB Lamba - 9 Power Ledli 10W/12V DC Full RGB Light with Niche - 9 Power Leds	ATS SUS034	190,00 €	1

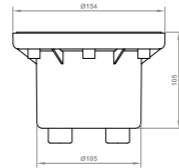
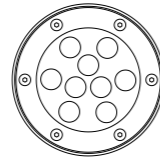

Ortası Delikli Ledli Aydınlatma Armatür
Atlaspool Fountain Perforated Led Light

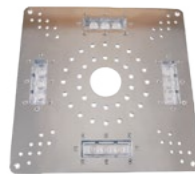

Malzeme Cinsi Description	Kod Code	Fiyat (Adet) Price (Pcs)	Koli/Adet Box/Pcs
30x30 Paslanmaz Kare Tip 12W/12V DC 12 Power Ledli Full RGB 30x30 Stainless Square Type 12W/12V DC 12 Power Leds Full RGB	ATS SUS039	400,00 €	1
40x40 Paslanmaz Kare Tip 12W/12V AC 12 Power Ledli Tek Renk 40x40 Stainless Square Type 12W/12V AC 12 Power Leds Unicolor	ATS SUS097	410,00 €	1
40x40 Paslanmaz Kare Tip 12W/12V DC 12 Power Ledli Full RGB 40x40 Stainless Square Type 12W/12V DC 12 Power Leds Full RGB	ATS SUS098	455,00 €	1
50x50 Paslanmaz Kare Tip 12W/12V AC 12 Power Ledli Tek Renk 50x50 Stainless Square Type 12W/12V AC 12 Power Leds Unicolor	ATS SUS099	395,00 €	1
50x50 Paslanmaz Kare Tip 12W/12V AC 12 Power Ledli Full RGB 50x50 Stainless Square Type 12W/12V AC 12 Power Leds Full RGB	ATS SUS100	440,00 €	1

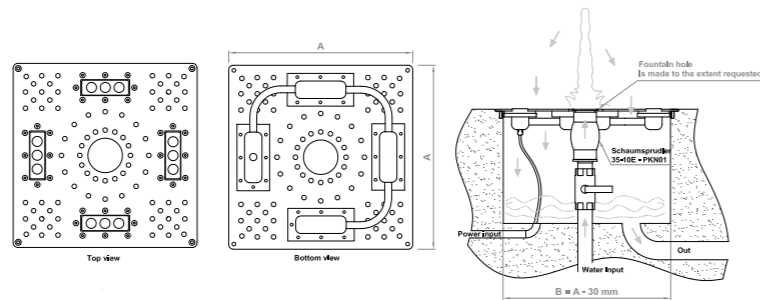

Paslanmaz Kaskad Nozullar
Stainless Cascade Nozzle

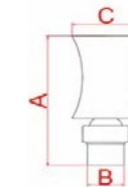

Malzeme Cinsi Description	Kod Code	Fiyat (Adet) Price (Pcs)	Koli/Adet Box/Pcs	Giriş
50 T	ATS SUS217	43,00 €	1	1 "
70 T	ATS SUS218	70,00 €	1	1 1/2 "
90 T	ATS SUS219	95,00 €	1	2 "
110 T	ATS SUS220	180,00 €	1	2 1/2 "
130 T	ATS SUS221	250,00 €	1	3 "

Parmak Fiskiye	50T	70T	90T	110T	130T
A	140	200	250	300	350
B	33,7	48,3	60,3	76,1	88,9
C	50	70	90	110	130
GR	365	755	1280	2440	2900

Komet Su Jeti Nozulları
Water Jet Nozzles Chrome Plated on Brass

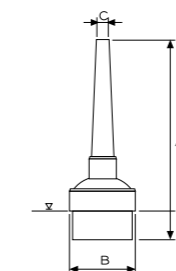

Malzeme Cinsi Description	Kod Code	Fiyat (Adet) Price (Pcs)	Koli/Adet Box/Pcs	Giriş
3/6 T	ATS SUS208	10,00 €	1	3/8"
5/8 T	ATS SUS209	15,00 €	1	1/2 "
5/10 T	ATS SUS210	15,00 €	1	1/2 "
8/10 T	ATS SUS211	20,00 €	1	3/4"
10/10 T	ATS SUS212	30,00 €	1	1"
10/12 T	ATS SUS213	30,00 €	1	1"
15/17 T	ATS SUS214	80,00 €	1	1 1/2"
15/20 T	ATS SUS215	80,00 €	1	1 1/2"
20/20 T	ATS SUS216	110,00 €	1	2"

Parmak Fiskiye	1/2 "	3/4"	1"	1 1/2"
A	93	104	107	157
B	21,3	26,9	33,7	48,3
C	8	10	12-14	17
GR	100	195	246	780

m	3/6 T lt/min	5/8 T lt/min	5/10 T lt/min	8/10 T lt/min	10/12 T lt/min	15/17 T lt/min	15/20 T lt/min
1,00	4,8	9,5	12	21	31	62	87
2,00	12,1	20,5	23	33	46	89	127
3,00				41	58	110	158
4,00				49	68	127	183
5,00				55	76	135	206
6,00				60	84	143	226
7,00					91	157	244
8,00					98	170	262
9,00						182	278
10,00						193	294
11,00						204	308
12,00						214	323

Çok Jetli Volkan Nozul
Multi-Jet Volcano Nozzle



Malzeme Cinsi Description	Kod Code	Fiyat (Adet) Price (Pcs)	Kg /Adet Kg/Pcs	Koli/Adet Box/Pcs
Çok Jetli Volkan Nozul 2" Multi-Jet Volcano Nozzle 2"	ATS SUS057	290,00 €	2,200	1

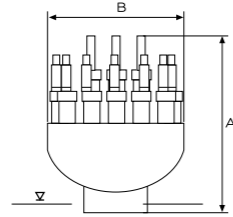

Volkan Fiskiye	2 "
A	187 mm
B	140 mm
Malzeme	Sarı
Nozul Sayısı	19

Debi: 1 metrede 12 m³/h

Gayzer (Çağlayan Gayzerleri)
Geysir Nozzle



Malzeme Cinsi Description	Kod Code	Fiyat (Adet) Price (Pcs)	Kg /Adet Kg/Pcs	Koli/Adet Box/Pcs
50T Çağlayan Gayzer - 1"içten dişli 50T Geysir Nozzle - 1" Female Threaded	ATS SUS058	43,00 €	0,240	1
70T Çağlayan Gayzer - 1 1/2"içten dişli 70T Geysir Nozzle - 1 1/2" Female Threaded	ATS SUS059	70,00 €	0,510	1
90T Çağlayan Gayzer - 2 " içten dişli 90T Geysir Nozzle - 2 " Female Threaded	ATS SUS060	95,00 €	0,820	1
110T Çağlayan Gayzer - 2 1/2 "içten dişli 110T Geysir Nozzle - 2 1/2 " Female Threaded	ATS SUS061	300,00 €	1,550	1
130T Çağlayan Gayzer - 3 "içten dişli 130T Geysir Nozzle - 3 " Female Threaded	ATS SUS062	540,00 €	5,470	1

Çağlayan Gayzer	50T	70T	90T	110T	130T
A	136 mm	182 mm	243 mm	230 mm	340 mm
B	51mm	75 mm	80 mm	96 mm	135 mm
C	118 mm	153 mm	187 mm	200 mm	295 mm
Malzeme	Sarı	Sarı	Sarı	Sarı	Sarı

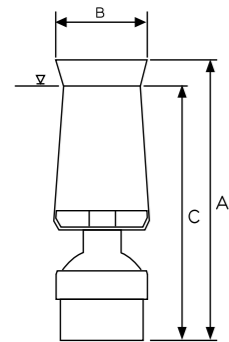

Yükseklik Height	50T 1"		70T 1 1/2"		90T 2"		110T 2 1/2"		130T 3"	
	m³/h	mss	m³/h	mss	m³/h	mss	m³/h	mss	m³/h	mss
1,00	2,63	4,10	5,82	4,00	9,43	3,30	19,57	2,90	22,78	3,60
2,00	3,49	7,30	7,48	6,60	12,49	5,80	21,44	5,30	29,30	6,00
3,00	4,49	12,00	8,84	9,20	14,95	8,30	22,92	7,60	34,63	8,40
4,00	4,78	13,60	10,01	11,80	17,06	10,90	26,23	10,00	39,25	10,80
5,00	5,30	16,80	11,07	14,40	18,95	13,40	29,18	12,30	43,38	13,40
6,00			12,04	17,10	20,66	15,90	31,86	14,70	47,20	15,50
7,00			12,93	19,70	22,25	18,50	34,35	17,10	50,70	17,90
8,00					23,74	21,00	36,66	19,50	54,00	20,40
10,00					26,48	26,10	40,94	24,20	60,06	25,20
12,00							44,82	29,10	65,64	30,10
14,00							48,41	33,90	70,80	35,00

(Metre) Yaşana bilecek dirsek kayıplarından kaynaklı hesaplamalar göz önüne alınmalıdır.

Gayzer Su Köpüğü Nozulları
Geysir Foam Nozzle



Malzeme Cinsi Description	Kod Code	Fiyat (Adet) Price (Pcs)	Koli/Adet Box/Pcs	Giriş
20 T	ATS SUS234	65,00 €	1	1 "
40 T	ATS SUS235	86,00 €	1	1 1/2 "
60 T	ATS SUS236	93,00 €	1	2 "
80 T	ATS SUS237	175,00 €	1	2 1/2 "
100 T	ATS SUS238	202,00 €	1	3 "

m	20 T lt/min	40 T lt/min	60 T lt/min	80 T lt/min	100 T lt/min
1,00	37	95	151	242	
2,00	47	115	189	301	459
3,00	46	133	220	350	532
4,00	64	149	247	394	596
5,00	71	163	272	433	653
6,00	77	176	295	469	707
7,00		188	316	503	757
8,00		199	336	534	803
10,00				593	890

İç İçe Borulu Ters Su Şemsiyesi
Foam Nozzle (Entwined Pipes Type)

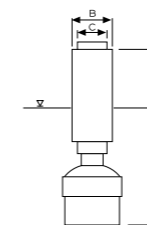

Malzeme Cinsi Description	Kod Code	Fiyat (Adet) Price (Pcs)	Kg /Adet Kg/Pcs	Koli/Adet Box/Pcs
İç İçe Borulu Köpük Nozul - 1" 1" Foam Nozzle (Entwined Pipes Type)	ATS SUS063	45,00 €	0,310	1
İç İçe Borulu Köpük Nozul - 2" 2" Foam Nozzle (Entwined Pipes Type)	ATS SUS064	88,00 €	0,960	1

İç İçe Borulu Köpük Nozul	1 "	2"
A	160 mm	215 mm
B	35 mm	55 mm
C	31 mm	45 mm
Malzeme	Sarı	Sarı

1" Debi : 1 metrede 7 m³/h

2" Debi : 1 metrede 12 m³/h

Film ve Parmak Yelpaze
Fan and Finger Nozzle



Malzeme Cinsi Description	Kod Code	Fiyat (Adet) Price (Pcs)	Kg /Adet Kg/Pcs	Koli/Adet Box/Pcs	Giriş
Paslanmaz Film Yelpaze Stainless Fan Nozzle	ATS SUS286	110,00 €		1	1"
Pirinç Döküm Film Yelpaze Brass Fan Nozzle	ATS SUS287	75,00 €		1	1"
Paslanmaz Parmak Yelpaze - 7li Stainless Finger Jet Nozzle With 7 Heads	ATS SUS288	157,00 €		1	1"
Pirinç Döküm ParmakYelpaze 19 lu Brass Finger Jet Nozzle With 19 Heads	ATS SUS289	175,00 €		1	1"



Su Çanı Nozulları
Water Bell Nozzle



Malzeme Cinsi Description	Kod Code	Fiyat (Adet) Price (Pcs)	Koli/Adet Box/Pcs	Giriş
30-10T	ATS SUS246	79,00 €	1	1"
45-10T	ATS SUS247	85,00 €	1	1"
60-10T	ATS SUS248	100,00 €	1	1"
100-10T	ATS SUS249	115,00 €	1	1"

Zambak Nozulları
Lilly Nozzle



Malzeme Cinsi Description	Kod Code	Fiyat (Adet) Price (Pcs)	Koli/Adet Box/Pcs	Giriş
30-10T	ATS SUS250	79,00 €	1	1"
45-10T	ATS SUS251	85,00 €	1	1"
60-10T	ATS SUS252	100,00 €	1	1"
100-10T	ATS SUS253	115,00 €	1	1"

Sisleme Nozulu
Foam Nozzle

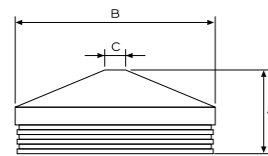

Malzeme Cinsi Description	Kod Code	Fiyat (Adet) Price (Pcs)	Kg /Adet Kg/Pcs	Koli/Adet Box/Pcs	Giriş
Sisleme Nozulu Foam Nozzle	ATS SUS071	72,00 €	0,200	1	1"

Sisleme Nozulu	1"
A	45 mm
B	58 mm
C	10 mm
Malzeme	San

Debi : 2 metrede 10 m³/h

Küre Fıskiyeler
Water Sphere Nozzle



Malzeme Cinsi Description	Kod Code	Fiyat (Adet) Price (Pcs)	Koli/Adet Box/Pcs	Giriş
900-37 E	ATS SUS258	①	1	30 M³ Ø90
1200-79 E	ATS SUS259	①	1	55 M³ Ø120
1500-127 E	ATS SUS260	①	1	85 M³ Ø150
2500-127 E	ATS SUS261	①	1	85 M³ Ø250



Malzeme Cinsi Description	Kod Code	Fiyat (Adet) Price (Pcs)	Koli/Adet Box/Pcs	Giriş
Ø50 cm	ATS SUS262	①	1	1"
Ø60 cm	ATS SUS263	①	1	1"
Ø80 cm	ATS SUS264	①	1	1"
Ø110 cm	ATS SUS265	①	1	1 1/2"
Ø150 cm	ATS SUS266	①	1	2"

Jumping Jet Fıskiye Sistemi
Jumping Jet Nozzle



Malzeme Cinsi Description	Kod Code	Fiyat (Adet) Price (Pcs)	Koli/Adet Box/Pcs
Jumping Jet Fıskiye Sistemi Jumping Jet Nozzle	ATS SUS277	①	1

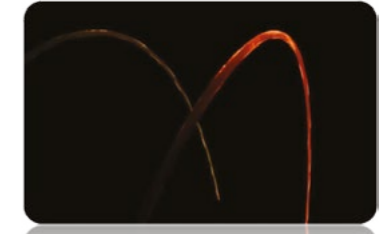

Dalgıç Pompa ve Motorlar
Submercible Pumps and Motors



Malzeme Cinsi Description	Kod Code	Fiyat (Adet) Price (Pcs)	Koli/Adet Box/Pcs
Dalgıç Pompa ve Motorlar Submercible Pumps and Motors	ATS SUS278	①	1

Tek Jetli Volkan Nozul
Jet Single Volcano Nozzle



Malzeme Cinsi Description	Kod Code	Fiyat (Adet) Price (Pcs)	Kg /Adet Kg/Pcs	Koli/Adet Box/Pcs
Tek Jetli Volkan Nozul - 1" 1" Jet Single Volcano Nozzle	ATS SUS076	55,00 €	0,260	1

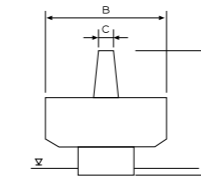

Tek Jetli Volkan Nozul	1"
A	93 mm
B	72 mm
C	8 mm
Malzeme	San

Debi : 1 metrede 3 m³/h

Jetsiz Volkan Nozul
Single Volcano Nozzle



Malzeme Cinsi Description	Kod Code	Fiyat (Adet) Price (Pcs)	Kg /Adet Kg/Pcs	Koli/Adet Box/Pcs
Jetsiz Volkan Nozul - 1" 1" Single Volcano Nozzle	ATS SUS077	48,00 €	0,260	1

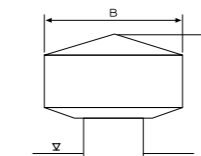

Tek Jetli Volkan Nozul	1"
A	76 mm
B	72 mm
Malzeme	San

Debi : 1 metrede 2 m³/h

Döner Fiskiye
Rotating Water Fountain Nozzle



Malzeme Cinsi Description	Kod Code	Fiyat (Adet) Price (Pcs)	Kg /Adet Kg/Pcs	Koli/Adet Box/Pcs
Döner Fiskiye - 1" Rotating Water Fountain Nozzle	ATS SUS078	105,00 €	0,770	1

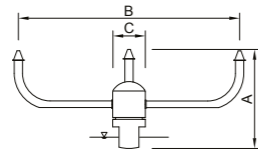

Döner Fiskiye	1 "
A	153 mm
B	370 mm
C	54 mm
Malzeme	Sarı

1" Debi : 1 metrede çap 1mt 7 m³/h

Volkan Fiskiye Nozulları
Volcano Fountain Nozzle



Malzeme Cinsi Description	Kod Code	Fiyat (Adet) Price (Pcs)	Kg /Adet Kg/Pcs	Koli/Adet Box/Pcs	Giriş
Üç Kademe Pirinç 3 Stage Brass	ATS SUS242	95,00 €		1	1"
Üç Kademe Pirinç 3 Stage Brass	ATS SUS243	220,00 €		1	2"

Malzeme Cinsi Description	Kod Code	Fiyat (Adet) Price (Pcs)	Kg /Adet Kg/Pcs	Koli/Adet Box/Pcs	Giriş
Üç Kademe Plastik 3 Stage Plastic	ATS SUS244	45,00 €		1	1"
Üç Kademe Plastik 3 Stage Plastic	ATS SUS245	95,00 €		1	2"



m	1" lt/min	2" lt/min
1,00	60	
2,00	90	
3,00	112	339
4,00	121	394
5,00	130	442
6,00		485
7,00		525

Döner Helezon Fiskiye
Rotating Fountain Nozzle

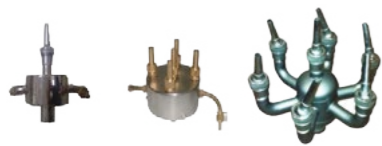

Malzeme Cinsi Description	Kod Code	Fiyat (Adet) Price (Pcs)	Kg /Adet Kg/Pcs	Koli/Adet Box/Pcs	Giriş
Sarhoş Dancing	ATS SUS254	189,00 €		1	1"
5 li Helezon 5 Head Spirals	ATS SUS255	252,00 €		1	1"-1 1/2"
6 li Helezon 6 Head Spirals	ATS SUS256	252,00 €		1	1 1/2"

m	1" Sarhoş lt/min	1" 5 li Helezon lt/min	1" 6 li Helezon lt/min	1 1/2" 5 li Helezon lt/min	1 1/2" 6 li Helezon lt/min
1,00	95	220	220	325	325
2,00	150	350	350	485	485
3,00	185	470	470	610	610
4,00	220	515	515	715	715
5,00	250	575	575	800	800
6,00	270	630	630	885	885



35-10E Köpük Nozul
35-10E Foam Nozzle

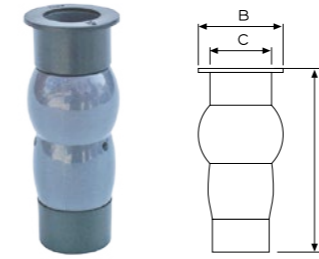

Malzeme Cinsi Description	Kod Code	Fiyat (Adet) Price (Pcs)	Kg /Adet Kg/Pcs	Koli/Adet Box/Pcs
35-10E Plastik Köpük Nozul - 1" 35-10E Plastic Foam Nozzle - 1"	ATS SUS079	30,00 €	0,140	1

35-10E Plastik Köpük Nozul	1 "
A	137 mm
B	54 mm
C	31 mm
Malzeme	Plastik

Debi : 1 metrede 7 m³/h

20-10E Köpük Nozul
20-10E Foam Nozzle

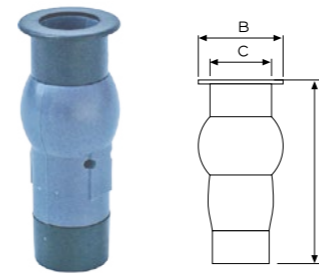

Malzeme Cinsi Description	Kod Code	Fiyat (Adet) Price (Pcs)	Kg /Adet Kg/Pcs	Koli/Adet Box/Pcs
20-10E Plastik Köpük Nozul - 1/2" 20-10E Plastic Foam Nozzle - 1/2"	ATS SUS080	24,00 €	0,070	1

20-10E Plastik Köpük Nozul	1/2"
A	102 mm
B	40 mm
C	23 mm
Malzeme	Plastik

Debi : 1 metrede 3 m³/h

Jetli Volkan Nozul
Volcano Nozzle



Malzeme Cinsi Description	Kod Code	Fiyat (Adet) Price (Pcs)	Kg /Adet Kg/Pcs	Koli/Adet Box/Pcs
Plastik Jetli Volkan Nozul - 1" 1" Plastic Volcano Nozzle	ATS SUS081	30,00 €	0,150	1
Plastik Jetli Volkan Nozul - 1/2" 1/2" Plastic Volcano Nozzle	ATS SUS082	23,00 €	0,020	1

Döner Fiskiye	1"	2"
A	93 mm	58 mm
B	104 mm	65 mm
Malzeme	Plastik	Plastik

Debi : 1 metrede 5 m³/h

Plastik Şemsiye Nozul

Plastic Umbrella Nozzle

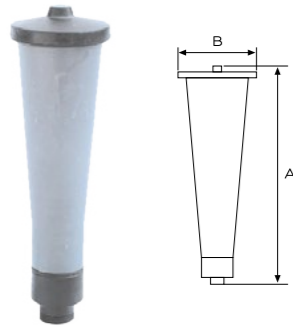

Malzeme Cinsi Description	Kod Code	Fiyat (Adet) Price (Pcs)	Kg /Adet Kg/Pcs	Koli/Adet Box/Pcs
Plastik Şemsiye Nozul - 1/2" 1/2" Plastic Umbrella Nozzle	ATS SUS083	23,00 €	0,070	1
Plastik Şemsiye Nozul	1/2"			
A	192 mm			
B	53 mm			
Malzeme	Plastik			
Debi : 0,30 metre çap 3 m³/h				

Plastik Kısa Şemsiye Nozul

Plastic Umbrella Nozzle (Small Type)

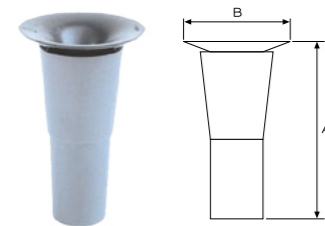

Malzeme Cinsi Description	Kod Code	Fiyat (Adet) Price (Pcs)	Kg /Adet Kg/Pcs	Koli/Adet Box/Pcs
Plastik Kısa Şemsiye Nozul - 1/2" 1/2" Plastic Umbrella Nozzle (Small Type)	ATS SUS084	23,00 €	0,060	1
Plastik Şemsiye Nozul	1/2"			
A	108 mm			
B	62 mm			
Malzeme	Plastik			
Debi : 0,30 metre çap 3 m³/h				

Plastik Mini Volkan Nozul

Mini Plastic Volcano Nozzle



Malzeme Cinsi Description	Kod Code	Fiyat (Adet) Price (Pcs)	Kg /Adet Kg/Pcs	Koli/Adet Box/Pcs
Plastik Mini Volkan Nozul - 1/2" 1/2" Mini Plastic Volcano Nozzle	ATS SUS085	13,00 €	0,020	1
Plastik Şemsiye Nozul	1/2"			
A	37 mm			
B	32 mm			
Malzeme	Plastik			
Debi : 1 metre çap 1,5 m³/h				

35-10E Paslanmaz Köpük Nozul

35-10E Stainless Foam Nozzle

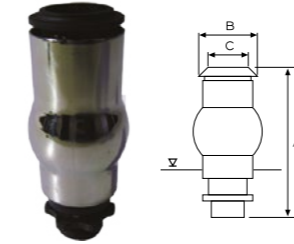

Malzeme Cinsi Description	Kod Code	Fiyat (Adet) Price (Pcs)	Kg /Adet Kg/Pcs	Koli/Adet Box/Pcs
1" İç Aksam Plastik 1" With Plastic Internal Part	ATS SUS086	45,00 €	0,280	1
1" Bronz Küreli	ATS SUS104	65,00 €	0,300	1

35-10E Paslanmaz Köpük Nozul	1"	Debi	Yükseklik	Debi	Yükseklik
A	157 mm	3,10 m³/h	0,25 mt	7,10 m³/h	2,00 mt
B	48 mm	3,90 m³/h	0,50 mt	7,80 m³/h	2,50 mt
C	31 mm	4,70 m³/h	0,75 mt	8,30 m³/h	3,00 mt
Malzeme	Paslanmaz	5,90 m³/h	1,00 mt	9,00 m³/h	3,50 mt
		6,50 m³/h	1,50 mt	9,60 m³/h	4,00 mt

55-15E Paslanmaz Köpük Nozul

55-15E Stainless Foam Nozzle

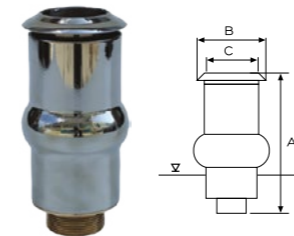

Malzeme Cinsi Description	Kod Code	Fiyat (Adet) Price (Pcs)	Kg /Adet Kg/Pcs	Koli/Adet Box/Pcs
1 1/2" Bronz Küreli	ATS SUS087	105,00 €	1,440	1
1 1/2" (İç aksam plastik)	ATS SUS105	80,00 €	1,400	1
1" Bronz Küreli	ATS SUS106	98,00 €	1,400	1

55-15E Paslanmaz Köpük Nozul	1/2"	Debi	Yükseklik	Debi	Yükseklik
A	195 mm	6,00 m³/h	0,25 mt	15,10 m³/h	2,00 mt
B	80 mm	7,50 m³/h	0,50 mt	17,00 m³/h	2,50 mt
C	48 mm	9,00 m³/h	0,75 mt	19,00 m³/h	3,00 mt
Malzeme	Paslanmaz	11,00 m³/h	1,00 mt	21,00 m³/h	3,50 mt
		13,00 m³/h	1,50 mt	23,00 m³/h	4,00 mt

75-20T Paslanmaz Köpük Nozul

75-20T Stainless Foam Nozzle

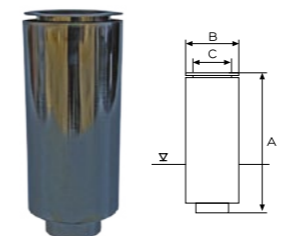

Malzeme Cinsi Description	Kod Code	Fiyat (Adet) Price (Pcs)	Kg /Adet Kg/Pcs	Koli/Adet Box/Pcs
2" Bronz Küreli	ATS SUS088	220,00 €	2,350	1

55-15E Paslanmaz Köpük Nozul	2"	Debi	Yükseklik	Debi	Yükseklik
A	265 mm	14,00 m³/h	0,25 mt	28,00 m³/h	2,00 mt
B	102 mm	16,00 m³/h	0,50 mt	32,00 m³/h	2,50 mt
C	72 mm	18,00 m³/h	0,75 mt	36,00 m³/h	3,00 mt
Malzeme	Paslanmaz	20,00 m³/h	1,00 mt	40,00 m³/h	3,50 mt
		24,00 m³/h	1,50 mt	44,00 m³/h	4,00 mt

Not / Note

SPA ÜRÜNLERİ

SPA PRODUCTS



Freedom Jet
Freedom Jet



Malzeme Cinsi Description	Kod Code	Fiyat (Adet) Price (Pcs)	Kg /Adet Kg/Pcs	Koli/Adet Box/Pcs
50x32 Freedom Jet Gövdesi 50x32 Freedom Jet Trunk	ATS SPA001	30,00 €	0,40	1
Freedom Jet Nozulu (Trim Kit) Freedom Jet Nozzle (Trim Kit)	ATS SPA002	23,00 €	0,09	1

50mm su x 32mm hava için masaj nozulları PVC den mamül.
50 mm Water x 32 mm air massage nozzle made of Plastic

Ekonomik Jetler
Economic Jet



Malzeme Cinsi Description	Kod Code	Fiyat (Adet) Price (Pcs)	Kg /Adet Kg/Pcs	Koli/Adet Box/Pcs
50x32 Ekonomik Jet Gövdesi 50x32 Economic Jet Trunk	ATS SPA003	25,00 €	0,40	1
Düz Görünümlü Standart Jet Nozulu Standard Straight Jet Nozzle	ATS SPA004	16,00 €	0,15	1
Düz Tip Doner Başlıklı Jet Nozulu Straight Type Adjustable Jet Nozzle	ATS SPA005	17,50 €	0,15	1
Damla Tip Doner Başlıklı Jet Nozulu Drop Type Adjustable Jet Nozzle	ATS SPA006	17,50 €	0,15	1

50mm su x 32mm hava için masaj nozulları PVC den mamül.
50 mm Water x 32 mm air massage nozzle made of Plastic

Magna Jetler
Magna Jet



Malzeme Cinsi Description	Kod Code	Fiyat (Adet) Price (Pcs)	Kg /Adet Kg/Pcs	Koli/Adet Box/Pcs
50x32 Ekonomik Jet Gövdesi 50 x 32 Economic Jet Trunk	ATS SPA007	45,00 €	0,40	1
Çift Ağızlı Doner Başlıklı Jet Nozulu Double Edge Adjustable Magna Jet Nozzle	ATS SPA008	35,00 €	0,12	1
Tek Ağızlı Doner Başlıklı Jet Nozulu Single Edge Adjustable Magna Jet Nozzle	ATS SPA009	35,00 €	0,12	1

50mm su x 32mm hava için masaj nozulları PVC den mamül.
50 mm Water x 32 mm air massage nozzle made of Plastic

Hava Ayar Tapası
Air Controller Stopper



Malzeme Cinsi Description	Kod Code	Fiyat (Adet) Price (Pcs)	Kg /Adet Kg/Pcs	Koli/Adet Box/Pcs
3/4" Hava Ayar Tapası 3/4 " Air Controller Stopper	ATS SPA010	18,00 €	0,03	1
1 1/4" Hava Ayar Tapası 1 1/4 " Air Controller Stopper	ATS SPA011	24,00 €	0,03	1
Ekonomik Hava Ayar Tapası Economic Air Controller Stopper	ATS SPA012	10,50 €	0,03	1

Hava Üfleme Nozulu
Magna Jet



Malzeme Cinsi Description	Kod Code	Fiyat (Adet) Price (Pcs)	Kg /Adet Kg/Pcs	Koli/Adet Box/Pcs
Yüksek Basıncılı 1" 16 Delikli ABS High-Pressure 1" 16 Holes Abs	ATS SPA013	20,00 €	0,02	1
Ekonomik Üfleme Nozulu Economic Blower Nozzle	ATS SPA014	15,00 €	0,02	1
Blower Nozulu Blower Nozzle	ATS SPA015	7,00 €	0,02	1

Pnömatik Buton
Pneumatic Pressbutton



Malzeme Cinsi Description	Kod Code	Fiyat (Adet) Price (Pcs)	Kg /Adet Kg/Pcs	Koli/Adet Box/Pcs
ABS Pnömatik Buton Abs Pneumatic Pressbutton	ATS SPA016	20,00 €	0,02	1
Krom Pnömatik Buton Chrome Pneumatic Pressbutton	ATS SPA017	24,00 €	0,02	1
Ekonomik Pnömatik Buton Economic Pneumatic Pressbutton	ATS SPA018	9,00 €	0,02	1

Emiş Süzgeci
Main Drain



Malzeme Cinsi Description	Kod Code	Fiyat (Adet) Price (Pcs)	Kg /Adet Kg/Pcs	Koli/Adet Box/Pcs
50 mm Delikli Tip Süzgeç 50 Mm Perforated Type Main Drain	ATS SPA019	27,00 €	0,04	1
50 mm Yapıştırılabilir Tip Süzgeç 50 Mm Glued Type Main Drain	ATS SPA020	24,00€	0,04	1
50 mm Krom Dişli Tip Süzgeç 50 Mm Chrome Threaded Type Main Drain	ATS SPA021	28,00 €	0,04	1

PVC Flex Hortum
PVC Flex Hose



Malzeme Cinsi Description	Kod Code	Fiyat (Adet) Price (Pcs)	Kg /Adet Kg/Pcs	Koli/Adet Box/Pcs
D 20 PVC Jakuzi Hortumu - 25 mt D 20 PVC Jacuzzi Hose - 25 mt	ATS SPA022	2,70 €	-	1
D 32 PVC Jakuzi Hortumu - 25 mt D 32 PVC Jacuzzi Hose - 25 mt	ATS SPA023	5,00 €	9,45	1
D 50 PVC Jakuzi Hortumu - 25 mt D 50 PVC Jacuzzi Hose - 25 mt	ATS SPA024	10,00 €	18,20	1
D 63 PVC Jakuzi Hortumu - 25 mt D 63 PVC Jacuzzi Hose - 25 mt	ATS SPA025	15,00 €	26,30	1

Pnömatik Şiş ve Şalter
Pneumatic Switch



Malzeme Cinsi Description	Kod Code	Fiyat (Adet) Price (Pcs)	Kg /Adet Kg/Pcs	Koli/Adet Box/Pcs
Pnömatik Şiş Pneumatic Switch	ATS SPA026	17,50€	-	1
Pnömatik Hortum - 1 mt'si Pneumatic Hose (1 mt)	ATS SPA027	1,00 €	-	1
Pnömatik Şalter 4 kw a kadar Trifaze pompalar için kontaktörü ve sigortasıyla komple.itthal plastik kutu içine montajlı. Pneumatic Switch Complete kit with contactor and fuse mounted in plastic box	ATS SPA028	266,00 €	0,75	1

Spa Serisi
Spa Series



Malzeme Cinsi Description	Kod Code	Fiyat (Adet) Price (Pcs)	Kg /Adet Kg/Pcs	Koli/Adet Box/Pcs	Debi (m³/h)
SPA Pompası - PF 500 0,70 hp / 0,53 kw SPA Pump - PF 500 0,70 hp / 0,53 kw	ATS SPA033	190,00 €	5,60	1	16,2
SPA Pompası - PF 750 0,90 hp / 0,75 kw SPA Pump - PF 750 0,90 hp / 0,75 kw	ATS SPA034	205,00 €	6,00	1	18,4
SPA Pompası - PF 1000 1.20 hp / 0,90 kw SPA Pump - PF 1000 1.20 hp / 0,90 kw	ATS SPA035	265,00 €	7,45	1	20,2
SPA Pompası - UA 200 2.00 hp / 1.50 kw SPA Pump - UA 200 2.00 hp / 1.50 kw	ATS SPA036	425,00 €	13,50	1	24,0

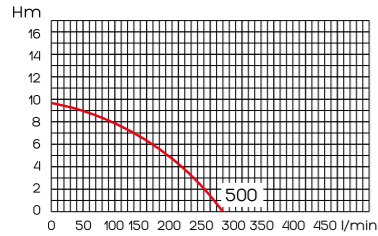

HM Pompası / Whirlpool Pump
Monofaze - Termal Koruma
Single Phase - Thermal Protection

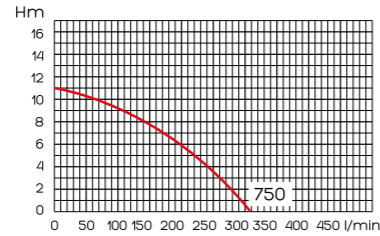

HM Pompası / Whirlpool Pump
Monofaze - Termal Koruma
Single Phase - Thermal Protection

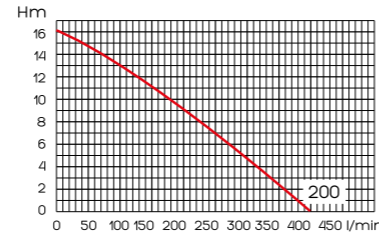

HM Pompası / Whirlpool Pump
Monofaze - Termal Koruma
Single Phase - Thermal Protection

Jetsetter Taşınabilir Jakuzi
?



Malzeme Cinsi Description	Kod Code	Fiyat (Adet) Price (Pcs)	Kg /Adet Kg/Pcs	Koli/Adet Box/Pcs
3 Kişilik Taşınabilir Jakuzi 3 person Portable Jacuzzi	ATS SPA038	20.750,00 €	204	1



Oturma Kapasite	3 Kişi
Ölçüler	2,13 m x 1,65 m x 0,74 m h
Su Kapasitesi	852 Litre
Ağırlık	215 kg boş, 1.305 kg dolu
Renk (İç)	Sedef veya beyaz
Renk (Dış)	Gri, Teak, Mocha
Jetler	1 Moto-Masaj® Jeti 1 Jet Stream 2 Döner Hidromasaj Jeti 1 Doğrusal Hidromasaj Jeti 4 Hydro Stream Jeti 4 Precision® Jet
Filtre Pompası	Silent Flo - 5000
Jet Pompası	Wavemaster® 9000 2,5 HP
Aydınlatma	Luminescence® dört renk
Kumanda Sistemi	IQ 2020™ LCD Ekran
Isıtıcı	No-Fault® 1500W
Ozon Sistemi	Fresh Water® III

MAPRO MARKA AVRUPA BLOWERLER
MAPRO BLOWERS
Santrifuj Blowerler / HS ve Turbostron Serileri

Tek Kademeli
Single Stage

Model	Güç kW Power	Çıkış Çapı Output	Debi Flow	0 mbar	10 mbar	20 mbar	30 mbar	40 mbar	50 mbar	60 mbar	70 mbar	80 mbar	90 mbar	100 mbar	Fiyat (Adet) Price (Pcs)
CL 20 HS	0,22	1 1/2"	m³/h	54	48	42	36	30	22	10	0				530,00 €
CL 20 HS	0,38	1 1/2"	m³/h	74	72	69	64	58	52	47	40	31	20	0	610,00 €

Model	Güç kW Power	Çıkış Çapı Output	Debi Flow	0 mbar	100 mbar	150 mbar	200 mbar	250 mbar	300 mbar	350 mbar	400 mbar	450 mbar	500 mbar	550 mbar	600 mbar	650 mbar	Fiyat (Adet) Price (Pcs)
CL 40 HS	1,1	1 1/2"	m³/h	150	90	59	30										674,00 €
CL 50 HS	1,5	2"	m³/h	212	151	116	82										855,00 €
CL 50 HS	2,2	2"	m³/h	214	151	116	82	50									888,00 €
CL 60 HS	3	2"	m³/h	300	230	192	155	117									1.119,00 €
CL 60 HS	4	2"	m³/h	300	230	192	155	117	82								1.210,00 €
CL 80 ZHS	5,5	2 1/2"	m³/h	518	418	380	344	308	272								2.280,00 €
CL 80 ZHS	7,5	2 1/2"	m³/h	518	418	380	344	308	272	236	200						2.558,00 €

Çift Kademeli
Double Stage

Model	Güç kW Power	Çıkış Çapı Output	Debi Flow	0 mbar	100 mbar	150 mbar	200 mbar	250 mbar	300 mbar	350 mbar	400 mbar	450 mbar	500 mbar	550 mbar	600 mbar	650 mbar	Fiyat (Adet) Price (Pcs)
CL 220 HS	0,7	1 1/4"	m³/h	86	58	44	31	20 (240 m bar)									975,00 €
CL 420 HS	1,5	1 1/2"	m³/h	154	122	106	90	74									1.382,00 €
CL 420 HS	2,2	1 1/2"	m³/h	154	122	106	90	74	58	42	26						1.505,00 €
CL 520 HS	3	2"	m³/h	236	203	185	167	249	131	113	95						1.999,00 €
CL 520 HS	4	2"	m³/h	236	203	185	167	249	131	113	95	77		65 (480 m bar)			2.168,00 €
CL 720 HS	3	2"	m³/h	324	288	270	252										2.310,00 €
CL 720 HS	4,3	2"	m³/h	324	288	270	252	234	216	198							2.513,00 €
CL 720 HS	5,5	2"	m³/h	324	288	270	252	234	216	198	171	153					2.840,00 €
CL 720 HS	7,5	2"	m³/h	324	288	270	252	234	216	198	171	153	135				3.054,00 €
CL 2R8	7,5	2 1/2"	m³/h	548	499	480	451	425	403	378							4.486,00 €
CL 2R8	11	2 1/2"	m³/h	548	499	480	451	425	403	378	354	330	306	275	250		4.705,00 €

Not: Fiyatlarımıza emiş filtresi, giriş ve çıkış susturucuları dahildir. Note: Inlet filters and output muffler is included in price

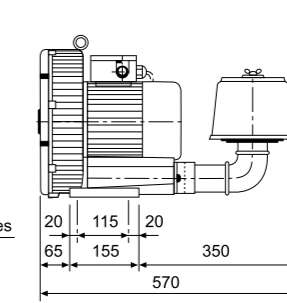
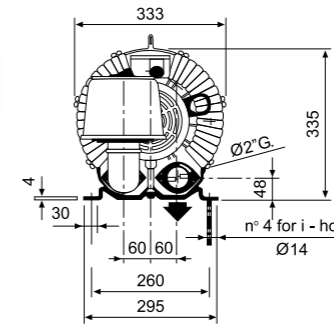

Pnömatik Buton Counter Current System



Malzeme Cinsi Description	Kod Code	Fiyat (Adet) Price (Pcs)	Kg /Adet Kg/Pcs	Koli/Adet Box/Pcs
3,0 HP Atlaspool pompalı Jet Stream 3,00 Hp Atlaspool Pump Jet Stream	ATS SPA039	1.545,00 €		1
3,5 HP Atlaspool pompalı Jet Stream 3,5 HP Atlaspool Pump Jet Stream	ATS SPA040	1.880,00 €		1
4,5 HP Atlaspool pompalı Jet Stream 4,5 HP Atlaspool Pump Jet Stream	ATS SPA041	1.925,00 €		1
5,5 HP Atlaspool pompalı Jet Stream 5,5 HP Atlaspool Pump Jet Stream	ATS SPA042	1.960,00 €		1
Elips Model Kovan ve ön çerçeve Takımı Elipse model Niche and Front Frame Kit	ATS SPA043	820,00 €		1

Jet pompası, pnömatik şalteri, vanaları ve bağlantı parçaları ile komple. Nozulu havuz içinde ayarlanabilir. ABS den üretilmiştir. Emiş hattı Ø75, basma hattı Ø63 dür. Emiş çekvalfi sayesinde hava emiş hattı su seviyesinin altına kurulabilir. Karşı akıntı sisteminin kurulumu kolaydır. İstenildiğinde çeşitli kW'larda pompa kullanmak mümkündür.

Jet pumps, pneumatic switchgear, valves and fittings set adjustable nozzle in pool. It made of Abs. Suction line Ø75 Pumping line Ø63. The inlet line can be installed below the water level by the inlet check valve. Counter current system installation is very easy. It is possible to use pump in various kW when requested.

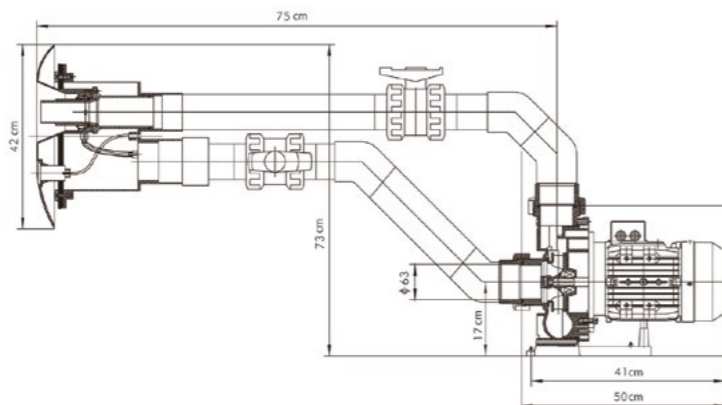
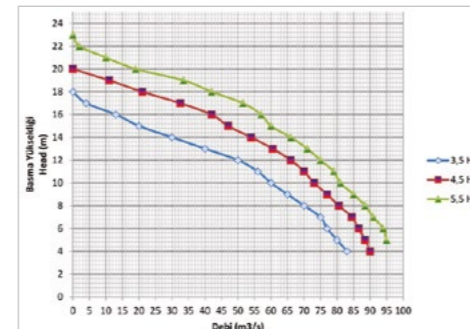
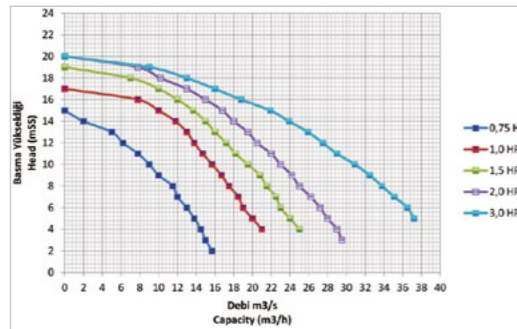

Pnömatik Buton Pnomatic Button

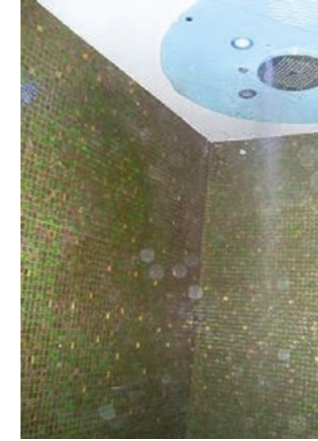

Malzeme Cinsi Description	Kod Code	Fiyat (Adet) Price (Pcs)	Kg /Adet Kg/Pcs	Koli/Adet Box/Pcs
Macera Duşu -1 Programlı Adventure Shower -1 Programmed	ATS SPA044	5,000,00 €		1
Macera Duşu - 2 Programlı Adventure Shower - 2 Programmed	ATS SPA045	5,500,00 €		1
Macera Duşu - 3 Programlı Adventure Shower - 3 Programmed	ATS SPA046	6,000,00 €		1

Duşunuzu tüm duygularınızı harekete geçirerek, kendinizi doğa ile başbaşa hissedeceğiniz unutulmaz bir maceraya dönüştürür.

EKİPMANLAR

Sis duşu, çise yağmur duşu, sağanak yağmur duşu, kokulandırma ünitesi, ses ünitesi (MP3 çalar ve marin hoperlör), ışık ünitesi (yıldız görünümlü ledler, renkli spot lambalar, gökkuşağı - opsiyonel), fonksiyon butonları, fonksiyon tablası, tesisat ekipmanları, sudaki kireci süzen ekipman, sudaki metalleri süzen ekipman, elektronik kontrol ünitesi, elektrik panosu, 1-2-3 adet senaryo, şelale (Opsiyonel), özel dekorasyon (opsiyonel).

TEKNİK ÖZELLİKLER

3/4" sıcak su girişi, 24V elektrik beslemesi. Macera duşu için bileşenler ön montajlı şekilde bir plakanın üzerinde hazırlanır. Plaka ihtiyaç ve isteklere bağlı olarak malzemeler monte edilir. Ilık / soğuk su, koku, ışık ve ses efektlerine sahip duşun önceden hazırlanmış senaryoya bağlı kalınarak harekete geçirilmesi ile konunun kendisini canlandırılan ortamda hissetmesi sağlanır.

Kabin girişindeki senaryo seçme düğmesi ile seçilen senaryoya ait işlemler sırası ile yapılmaya başlanır. Örneğin valfler aracılığı ile yağmur efektleri, sis efekti oluşturulur, koku dozlama ile ortama değişik kokular verilir.

Süre: Ön tanımlı senaryolar 30 sn ile 45 sn arasında değişir. İstenirse daha uzun süreli ve değişik dizilişlerde senaryo hazırlanabilir.

ÖRNEK SENARYOLAR

SENARYO 1

Program sis ile başlar, ardından gök-kuşağı görülür, sis yerini ılık çiseleme yağmuruna bırakır. Gökkuşağı yok olur, aydınlatma sarıya geçiş yapar kuş ses-leri duyulur. Ardından ılık bir sağnak soğuk sağnak yağışa dönüşür. Sağnak yağış kesilerek yerini sise bırakır ortama toprak kokusu verilir gökyüzünde yıldızlar görülür.

SENARYO 2

Program ılık sağnak yağışla başlar, aydınlatma kırmızıdan yeşile döner, ortama tropik orman kuş sesleri ve tropik meyve kokusu yayılır. Ardın-dan soğuk sis yayılır ve tropik yağmu-ra dönüşür. Aydınlatma sarıya döner, program gökyüzünde yıldız ışıltısıyla sonlanır.

SENARYO 3

Program soğuk sis ile başlar, aydın-latma yeşilden maviye geçer. Gök-gürültüsü duyulur, ardından şimşek çakar. Sis yerini soğuk sağnak yağışa bırakır. Sağnak yağış hafifler ve durur. Program şelaleden gelen su ile sonlanır.

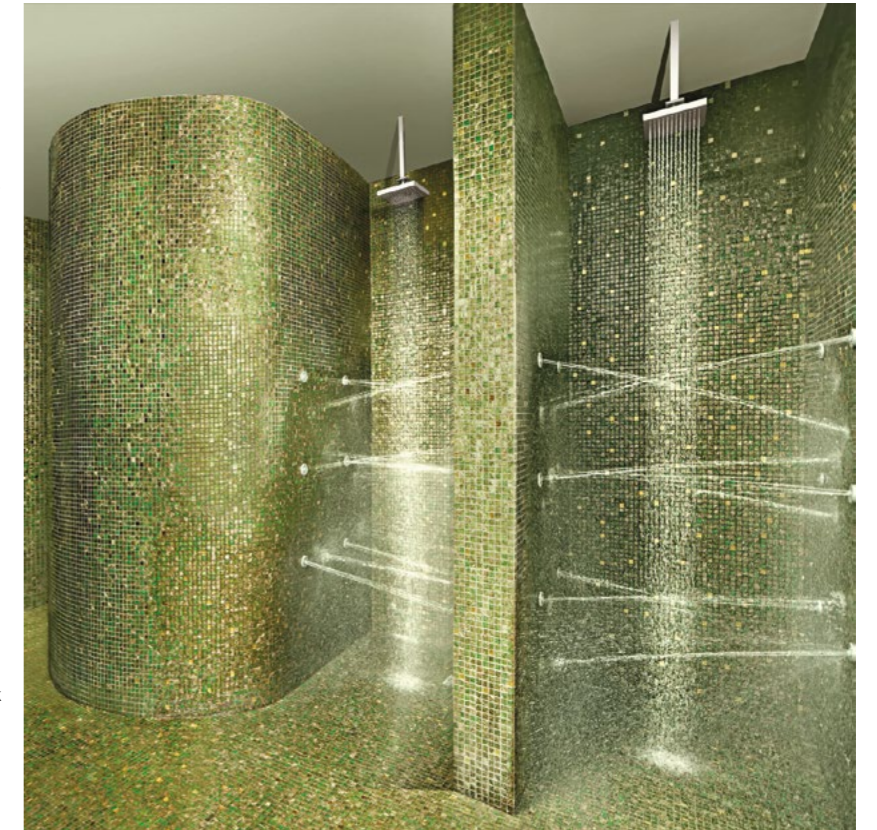

Not / Note

SAUNA MALZEMELERİ SAUNA EQUIPMENTS



Sauna Isıtıcıları / Mini, Üzerinden Kumandalı

Sauna Heater (mini) With Remote Control



Malzeme Cinsi Description	Kod Code	Fiyat (Adet) Price (Pcs)	Kg /Adet Kg/Pcs	Koli/Adet Box/Pcs	Sauna m³	Ebat Dimensions
Mini 3 kW	ATS SAU001	336,00 €	8,00	1	1,5-3	65x24x34
Mini 3,6 kW	ATS SAU002	346,00 €	8,00	1	2-4,5	65x24x34

Not: Taş kapasitesi 10 kg dır.Fiyata dahil değildir.
Note: Stone Capacity: 10 kg It is not included in price.

Sauna Isıtıcıları / FTN, Üzerinden Kumandalı

Sauna Heater / FTN With Remote Control



Malzeme Cinsi Description	Kod Code	Fiyat (Adet) Price (Pcs)	Kg /Adet Kg/Pcs	Koli/Adet Box/Pcs	Sauna m³	Ebat Dimensions
FTN 3 kW	ATS SAU003	297,00 €		1	2-4	570x400x270
FTN 4,5 Kw	ATS SAU004	314,00 €		1	3-6	570x400x270
FTN 6 kW	ATS SAU005	330,00 €		1	5-9	570x400x270
FTN 8 kW	ATS SAU006	346,00 €		1	8-12	570x400x270
FTN 9 kW	ATS SAU007	359,00 €		1	9-13	570x400x270

Not: Taş kapasitesi 20 kg'dır. Fiyata dahil değildir.
Note: Stone Capacity: 20 kg It is not included in price.

Sauna Isıtıcıları / FTC, Harici Kumandalı

Sauna Heater / FTN With External Remote Control



Malzeme Cinsi Description	Kod Code	Fiyat (Adet) Price (Pcs)	Kg /Adet Kg/Pcs	Koli/Adet Box/Pcs	Sauna m³	Ebat Dimensions
FTC 3 kW	ATS SAU008	256,00 €		1	2-4	570x400x270
FTC 4,5 Kw	ATS SAU009	262,00 €		1	3-6	570x400x270
FTC 6 kW	ATS SAU010	272,00 €		1	5-9	570x400x270
FTC 8 kW	ATS SAU011	290,00 €		1	8-12	570x400x270
FTC 9 kW	ATS SAU012	310,00 €		1	9-13	570x400x270

Not: Taş kapasitesi 20 kg'dır. Fiyata dahil değildir.
Note: Stone Capacity: 20 kg It is not included in price.

Sauna Isıtıcıları / FTC, Harici K. ve Güç Kontrol Paneli

Sauna Heater / FTC Without Door Remote Control



Malzeme Cinsi Description	Kod Code	Fiyat (Adet) Price (Pcs)	Kg /Adet Kg/Pcs	Koli/Adet Box/Pcs	Sauna m³	Ebat Dimensions
FTC 10,5 kW	ATS SAU013	1.195,00 €		1	10-15	685x510x575
FTC 12 kW	ATS SAU014	1.235,00 €		1	11-18	685x510x575
FTC 15 kW	ATS SAU015	1.278,00 €		1	14-24	685x510x575
FTC 18 kW	ATS SAU016	1.910,00 €		1	18-30	685x510x575
FTC 21 kW	ATS SAU017	2.048,00 €		1	23-36	685x510x575
FTC 27 kW	ATS SAU018	2.182,00 €		1	29-47	685x510x575

Not: Taş kapasitesi 10,5/12/15 kW soba için 40 kg, 18/21/27 kW soba için ise 60 kg dır.
Taş fiyata dahil değildir.

Note: Stone Capacity is 40 kg for 10,5/12/15 kw stove.Stone Capacity is 60 kg for 18/21/27 kw stove.
Stone is not included in price.

Kumanda Panosu/Manuel

Control Panel /Manue



Malzeme Cinsi Description	Kod Code	Fiyat (Adet) Price (Pcs)	Kg /Adet Kg/Pcs	Koli/Adet Box/Pcs
Manuel 3-9 kW	ATS SAU019	140,00 €		1
Manuel 10,5-15 kW	ATS SAU020	160,00 €		1
Manuel 18-30 kW	ATS SAU021	130,00 €		1

Kumanda Panosu/Dijital

Control Panel /Digital



Malzeme Cinsi Description	Kod Code	Fiyat (Adet) Price (Pcs)	Kg /Adet Kg/Pcs	Koli/Adet Box/Pcs
Dijital 3-9 kW	ATS SAU022	180,00 €		1
Dijital 10,5-15 kW	ATS SAU023	190,00 €		1
Dijital 18-30 kW	ATS SAU024	160,00 €		1

Güç Kontrol Paneli

Power Control Panel



Malzeme Cinsi Description	Kod Code	Fiyat (Adet) Price (Pcs)	Kg /Adet Kg/Pcs	Koli/Adet Box/Pcs
15-30 kW	ATS SAU025	290,00 €		1

Not: Kumanda paneline ilave olarak güç kontrol paneli 15/18/21/27 kW sobalar için kullanılması zorunludur.
Note: In addition to the control panel, it is necessary to use it for 15/18/21/27 kw stove with power control panel

Sauna Sobası Taşı

Sauna Stove Stone



Malzeme Cinsi Description	Kod Code	Fiyat (Adet) Price (Pcs)	Kg /Adet Kg/Pcs	Koli/Adet Box/Pcs
Sauna Soba Taşı Sauna Stove Stone	ATS SAU026	20,00 €	10 kg	1
Sauna Soba Taşı Sauna Stove Stone	ATS SAU027	30,00 €	20 kg	1

Sauna Esansı

Sauna Essence



Malzeme Cinsi Description	Kod Code	Fiyat (Adet) Price (Pcs)	Kg /Adet Kg/Pcs	Koli/Adet Box/Pcs
Sauna Esansı Sauna Essence	ATS SAU028	17,00 €	250 ml	1
Sauna Esansı Sauna Essence	ATS SAU029	35,00 €	1000 ml	1

Sauna Ahşap Termometre ve Higrometre

Wooden Sauna Thermometer- Hygrometer



Malzeme Cinsi Description	Kod Code	Fiyat (Adet) Price (Pcs)	Koli/Adet Box/Pcs
Sauna Ahşap Termometresi Wooden Sauna Thermometer	ATS SAU030	45,00 €	1
Sauna Ahşap Higrometresi Wooden Sauna Hygrometer	ATS SAU031	59,00 €	1
Sauna Ahşap Termo-Higro (Kombine) Wooden Sauna Thermometer- Hygrometer (Combined)	ATS SAU032	98,00 €	1

Sauna Plastik Termometre ve Higrometre

Plastic Sauna Thermometer- Hygrometer



Malzeme Cinsi Description	Kod Code	Fiyat (Adet) Price (Pcs)	Koli/Adet Box/Pcs
Sauna Plastik Termometresi Plastic Sauna Thermometer	ATS SAU033	26,00 €	1
Sauna Plastik Higrometresi Plastic Sauna Hygrometer	ATS SAU034	28,00 €	1
Sauna Plastik Termo-Higro (Kombine) Plastic Sauna Thermometer- Hygrometer (Combined)	ATS SAU035	45,00 €	1

Sauna Ahşap Saati

Wooden Sauna Clock



Malzeme Cinsi Description	Kod Code	Fiyat (Adet) Price (Pcs)	Koli/Adet Box/Pcs
Sauna Ahşap Saati Wooden Sauna Clock	ATS SAU036	62,00 €	1

Kum Saati

Sand Watch Fo



Malzeme Cinsi Description	Kod Code	Fiyat (Adet) Price (Pcs)	Koli/Adet Box/Pcs
Sauna Kum Saati 15 Dk'lık Sand Watch For 15 Minutes	ATS SAU037	25,00 €	1

Ahşap Kova ve Keççe

Wooden Bucket and Scoop



Malzeme Cinsi Description	Kod Code	Fiyat (Adet) Price (Pcs)	Koli/Adet Box/Pcs
Sauna Ahşap Kovası Wooden Sauna Bucket	ATS SAU038	50,00 €	1
Sauna Ahşap Keççesi Wooden Sauna Scoop	ATS SAU039	20,00 €	1

Bakır Kova ve Keççe

Copper Bucket and Scoop



Malzeme Cinsi Description	Kod Code	Fiyat (Adet) Price (Pcs)	Koli/Adet Box/Pcs
Sauna Bakır Kovası Copper Sauna Bucket	ATS SAU040	46,00 €	1
Sauna Bakır Keççesi Copper Sauna Scoop	ATS SAU041	28,00 €	1

Sauna Kapıları

Sauna Door



Malzeme Cinsi Description	Kod Code	Fiyat (Adet) Price (Pcs)	Koli/Adet Box/Pcs
Ahşap Sauna Kapısı 190x80 Wooden Sauna Door 190x80	ATS SAU042	256,00 €	1
Cam Sauna Kapısı 200x80 Glass Sauna Door 200x80	ATS SAU043	359,00 €	1
Cam Sauna Kapısı 210x80 Glass Sauna Door 210x80	ATS SAU044	387,00 €	1
Sauna Kapıları için Ahşap Tutamak Seti Wooden Handle For Sauna Door	ATS SAU045	64,00 €	1

Kapı Kilitleri ve Mentеше

Door Locks and Hinge

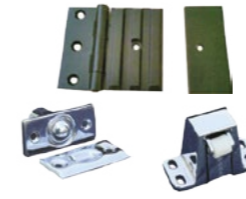

Malzeme Cinsi Description	Kod Code	Fiyat (Adet) Price (Pcs)	Koli/Adet Box/Pcs
Kapı Kiliti - Ekonomik Door Lock-Economic	ATS SAU046	52,00 €	1
Kapı Kiliti - Lüks Door Lock-Lux	ATS SAU047	68,00 €	1
Kapı Mentеше Door Hinge	ATS SAU048	39,00 €	1

Kapı Kilitleri ve Mentеше

Wooden Ventilation



Malzeme Cinsi Description	Kod Code	Fiyat (Adet) Price (Pcs)	Koli/Adet Box/Pcs
Sauna Havalandırma Klepesi Sürgülü Wooden Sliding Ventilation	ATS SAU049	28,00 €	1
Sauna Havalandırma Klepesi Izgaralı Wooden Grid Ventilation	ATS SAU050	28,00 €	1

Kapı Kilitleri ve Mentеше

Sauna Lamp

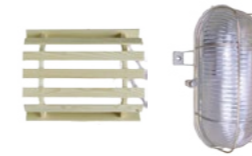

Malzeme Cinsi Description	Kod Code	Fiyat (Adet) Price (Pcs)	Koli/Adet Box/Pcs
Ahşap Koruma Aplık için Wooden Lamp Shade	ATS SAU051	32,00 €	1
Aydınlatma Armatürü Lamp Armature	ATS SAU052	40,00 €	1

Kapı Kilitleri ve Mentеше

Sauna- Wooden Headrests



Malzeme Cinsi Description	Kod Code	Fiyat (Adet) Price (Pcs)	Koli/Adet Box/Pcs
Sauna için Ahşap Yastık Wooden Headrests For Sauna	ATS SAU053	39,00 €	1

Kar Çeşmesi Snow Fountain



Malzeme Cinsi Description	Kod Code	Fiyat (Adet) Price (Pcs)	Koli/Adet Box/Pcs
Kar Çeşmesi Snow Fountain	ATS SAU054	11.000,00 €	1

Hamam ve sauna sonrası ısınmış olan vücudu soğutmak için kullanılır. Buz parçaları vücuda uygulanır. Bu uygulama kan dolaşımını hızlandırır, cildi sıkılaştırır ve daha pürüzsüz görünmesini sağlar. Tamamen doğal olup hiçbir kimyasal madde içermemektedir. İsteğinize uygun dekorasyon ve kapasitede projelendirme çalışması yapılabilir. Kabin içerisine uygun ambiyansı oluşturacak dekorla standart, portatif, demonte. Açık alanda belirlenen duvara uygulanan kar - buz çeşmeleri için teknik oda oluşturulması gerekmektedir. Kar odası gibi aynı sistemle çalışan, ancak kabin içerisinde olmayan ürünümüz, geri planda kalmış geniş havzede biriken kar taneciklerinin kumadan dökülmesi şeklinde çalışır. Kar çeşmesi değişik modellerde isteğe ve yere göre uygulanabilir.

EKİPMANLAR

Kar-buz haznesi, kar biriktirme çanağı, dekoratif gövde; standart cam-mozaiik kaplı, isteğe bağlı dekorasyon (Opsiyonel).

TEKNİK ÖZELLİKLER

200 kg / gün kar üretme kapasitesi, 220 V elektrik beslemesi, 1/2" soğuk su girişi.



Isıtmalı Yatak Heated Lounger



Malzeme Cinsi Description	Kod Code	Fiyat (Adet) Price (Pcs)	Koli/Adet Box/Pcs
Isıtmalı Yatak Heated Lounger	ATS SAU056	2.420,00 €	1

Sıcak ve soğuk banyo arasında yerleştirilmiş ılık bir ortamdır. Vücudun sıcak mekandan soğuk mekana geçişi kolay adapte olmasını sağlar. Üzerindeki kontrol panelleri ile ısı derecesi ayarlanabilen, özel mozaiklerle kaplanmış, vücudun rahatlaması ve dinlenmesine yardımcı olan yataklarımızla kaslarda oluşan kramplar ve gerginlikler çözülür, romatizmal ağrılar azalır. Yavaş yayılan ısı tüm organizmayı harmonize eder. Isıtılmış yatakların olumlu etkileri; Vücudu zorlamadan kan dolaşımını düzenler. Başışıklık sistemini güçlendirir. Merkezi sinir sistemi üzerinde sakinleştirici etkisi vardır. Stresi azaltarak rahatlamayı sağlar. Türnal Spa seansları arasında ideal bir dinlenme sağlar.

EKİPMANLAR

Ergonomik dinlenme koltuğu, standart cam-mozaiik yüzey kaplaması, yüzey ısıtma, yüzey ısıtma kumanda paneli.

TEKNİK ÖZELLİKLER

220 V elektrik beslemesi.



Buhar Jeneratörleri Steam Generator



Malzeme Cinsi Description	Kod Code	Fiyat (Adet) Price (Pcs)	Kg /Adet Kg/Pcs	Koli/Adet Box/Pcs
3 kW Buhar Jeneratörü - 2,5 m³ 3 kW Steam Generator - 2,5 m³	ATS SAU057	1.195,00 €	13,00	1
4,7 kW Buhar Jeneratörü - 5 m³ 4,7 kW Steam Generator - 5 m³	ATS SAU058	1.220,00 €	13,00	1
6 kW Buhar Jeneratörü - 7 m³ 6 kW Steam Generator - 7 m³	ATS SAU059	1.325,00 €	13,00	1
8 kW Buhar Jeneratörü - 9 m³ 8 kW Steam Generator - 9 m³	ATS SAU060	1.420,00 €	13,00	1
9 kW Buhar Jeneratörü - 11 m³ 9 kW Steam Generator - 11 m³	ATS SAU061	1.720,00 €	13,00	1
10 kW Buhar Jeneratörü - 12 m³ 10 kW Steam Generator - 12 m³	ATS SAU062	1.750,00 €	13,00	1
12 kW Buhar Jeneratörü - 14 m³ 12 kW Steam Generator - 14 m³	ATS SAU069	1.780,00 €	15,00	1
14 kW Buhar Jeneratörü - 16 m³ 14 kW Steam Generator - 16 m³	ATS SAU070	1.825,00 €	15,00	1
18 kW Buhar Jeneratörü - 20 m³ 18 kW Steam Generator - 20 m³	ATS SAU071	2.190,00 €	19,00	1
21 kW Buhar Jeneratörü - 23 m³ 21 kW Steam Generator - 23 m³	ATS SAU072	2.410,00 €	19,00	1
3-21 kW Buhar Jeneratörü Kumanda Panosu 3-21 kW Steam Generator Control Panel	ATS SAU063	450,00 €	-	1

Malzeme Cinsi Description	Kod Code	Fiyat (Adet) Price (Pcs)	Kg /Adet Kg/Pcs	Koli/Adet Box/Pcs
Buhar Odası Kapısı - 185x78x6,5 cm Steam Room Door - 185x78x6,5 cm	ATS SAU064	835,00 €	-	1
Buhar Odası Kapısı - 207x89x6,5 cm Steam Room Door - 207x89x6,5 cm	ATS SAU065	900,00 €	-	1
Buhar Odası Kapısı Tutamak Seti Steam Room Door Handle Set	ATS SAU066	80,00 €	-	1
Buhar Çıkış Ağızı Steam Out Equipment	ATS SAU067	80,00 €	-	1
Buhar Odası Apliği Steam Room Wall Lamp	ATS SAU068	40,00 €	-	1





Since 1977

PIMTAS®

PLASTİK İNŞ. MALZ.SAN. VE TİC. A.Ş.



Pelitli Mahallesi 4443. Sokak No:6 41400 Gebze / KOCAELİ / TÜRKİYE

+90 262 751 24 24 +90 262 751 42 04 pimtas@pimtas.com

www.pimtas.com / www.pimtasshop.com